



THS[®]
THERMOSTYLE



CATALOGUE

PLUMBING AND HEATING
ВОДОПРОВОД И ОТОПЛЕНИЕ

2025

Το THS Thermostyle είναι εμπορικό σήμα κατατεθέν Βουλγαρίας καταχωρημένο από την ΟΗΜ με πιστοποιητικό № 010276855/27.02.2012. Όλα τα προϊόντα κατασκευάζονται σύμφωνα με τις τεχνικές προδιαγραφές, εξασφαλίζοντας την αξιοπιστία της εταιρίας. Τα προϊόντα είναι πιστοποιημένα σύμφωνα με τις Βουλγάρικες και Ευρωπαϊκές προδιαγραφές ποιοτικού ελέγχου.

Το εύρος των προϊόντων κυμαίνεται μεταξύ 3/8" έως 4" και συμπεριλαμβάνει μεγάλη γκάμα εξαρτημάτων για υδραυλικά και θέρμανση.

Όλα τα προϊόντα με το εμπορικό σήμα THS Thermostyle έχουν 5 χρόνια εγγύηση, εκτός αν αναφέρεται κάτι διαφορετικό.

Επιλέγοντας το εμπορικό σήμα THS Thermostyle, επιλέγετε ασφάλεια και ποιότητα σε ανταγωνιστική τιμή.

THS Thermostyle is a Bulgarian trademark registered by OHIM **with a certificate № 010276855 / 27.02.2012.**

All products are manufactured in compliance with **technology standards to ensure their reliability. Certified in** accordance with Bulgarian and European quality control requirements. Wide product range from 3/8" to 4", including a **wide assortment of plumbing and heating fittings. All products** with the trademark THS Thermostyle have a 5-year warranty. **Except the products mentioned with a different warranty.**

By choosing the THS Thermostyle brand you choose security and quality at a competitive price.

THS[®]
Thermostyle, EU, Bulgaria, Sofia



Αποκλειστικοί Διανομείς Ελλάδας

YFANTIS GROUP
Energy Solutions est. 1980

Climaland

ΚΑΡΑΠΙΝΙΔΗΣ
Climaland

Ν. Φιλαδέλφεια, Αθήνα, Λ. Θεσσαλονίκης 6, Τ.Κ. 143 42
Τ: 210 25 30 115, F: 210 25 22 735
www.climaland.gr info@climaland.gr

Δελφών 31, Θεσσαλονίκη
Τ: 2316 020 224
www.karapinidis-climaland.gr info@karapinidis.gr

Δακώπτες Απλοί και Σφαιρικοί	1-5	Αυτόματα Εξαεριστικά Δικτύου	81-82
Δακώπτες Γωνιακοί - Διακώπτες Γωνιακοί Διακοσμητικοί	7-12	Θερμοστατικοί Διακώπτες & Διακώπτες Καλοριφέρ Διακοσμητικοί	83-94
Βαλβίδες Αντεπιστροφής- Μειωτές Πίεσεως	14-15	Θερμοστατικές Κεφαλές	95-96
Κάνουλες Σφαιρικές - Κάνουλες Διακοσμητικές	18-22	Συλλέκτες Ύδρευσης - Θέρμανσης	98-100
Ορειχάλκινα εξαρτήματα χρωμέ	23-27	Εξοπλισμός Ενδοδαπέδιας Θέρμανσης	101-102
Ορειχάλκινα εξαρτήματα	30-34	Ρακόρ & Εξαρτήματα Συλλεκτών	103
Ρακόρ και βαλβίδες ασφαλείας	35	Εξαρτήματα Συσφίξεως Πολυστ/τικής	104-107
Μπαταρίες Λουτρού - Νιπτήρος - Κουζίνας και Αξεσουάρ	38-54	Εξαρτήματα Press Πολυστ/τικής	108-109
Ανταλλακτικά Μπαταριών	55-60	Μίνι Διακώπτες	110
Σπιράλ Λουτρού - Σχαράκια - Σιφώνια	62-64	Πίνακες Υδροληψίας	111
Υγρό Τεφλόν - Κανάβι	65	Κυκλοφορητές	112
Πετσετοκρεμάστρες	68-75	Μανόμετρα - Βαλβίδες Ασφαλείας	113
Αντιστάσεις για Πετσετοκρεμάστρες	76-77	Δοχεία Διαστολής	114-116
Στηρίγματα Σωμάτων	79	Μαγνητικό Φίλτρο	117
Εξαρτήματα Σωμάτων Αλουμινίου	80	Σετ Στήριξης Δοχείου Διαστολής	118





ΣΦΑΙΡΙΚΟΙ ΔΙΑΚΟΠΤΗΣ CAST IRON GLOBE VALVES

ΣΦΑΙΡΙΚΟΣ ΔΙΑΚΟΠΤΗΣ
CAST IRON GLOBE VALVE



ΔΙΑΣΤΑΣΗ Dimension	ΚΩΔΙΚΟΣ Item №	Barcode		ΤΙΜΗ
1/2"	100089	3800154052279	12/72	5,61
3/4"	100090	3800154052309	1/48	7,26
1"	100091	3800154052330	6/36	11,82

ΣΦΑΙΡΙΚΟΣ ΔΙΑΚΟΠΤΗΣ
CAST IRON GLOBE VALVE



ΔΙΑΣΤΑΣΗ Dimension	ΚΩΔΙΚΟΣ Item №	Barcode		ΤΙΜΗ
1 1/4"	2510	3800154052200	3/18	22,17
1 1/2"	896	3800154052217	4/16	33,01
2"	2467	3800154052262	2/8	52,40

ΣΦΑΙΡΙΚΟΣ ΔΙΑΚΟΠΤΗΣ
CAST IRON GLOBE VALVE



ΔΙΑΣΤΑΣΗ Dimension	ΚΩΔΙΚΟΣ Item №	Barcode		ΤΙΜΗ
1 1/4"	99996	3800154052545	3/18	17,00
1 1/2"	99997	3800154052484	4/16	25,81
2"	99998	3800154052514	2/8	41,58

THS[®]
THERMOSTYLE



ΔΙΑΚΟΠΤΕΣ ΟΡΕΙΧΑΛΚΙΝΟΙ BRASS STOP VALVES

ΔΙΑΚΟΠΤΗΣ ΟΡΕΙΧΑΛΚΙΝΟΣ BRASS STOP VALVE



ΔΙΑΣΤΑΣΗ Dimension	ΚΩΔΙΚΟΣ Item №	Barcode		ΤΙΜΗ
1/2"	40001	3800154007811	16/192	6,81
3/4"	40002	3800154007828	10/120	10,35
1"	40008	3800154018961	6/72	17,82

ΔΙΑΚΟΠΤΗΣ ΜΕ ΕΞΑΕΡΙΣΤΙΚΟ BRASS STOP VALVE WITH AIRVENT



ΔΙΑΣΤΑΣΗ Dimension	ΚΩΔΙΚΟΣ Item №	Barcode		ΤΙΜΗ
1/2"	40003	3800154007835	8/96	9,88
3/4"	40004	3800154007842	6/72	13,94

ΜΗΧΑΝΙΣΜΟΣ ΚΛΕΙΣΙΜΑΤΟΣ ΓΙΑ ΔΙΑΚΟΠΤΗ BRASS CARTAGE FOR BRASS STOP VALVE



ΔΙΑΣΤΑΣΗ Dimension	ΚΩΔΙΚΟΣ Item №	Barcode		ΤΙΜΗ
Μηχανισμός 1/2" for brass stop valve 1/2"	40005	3800154007859	20/240	3,85
Μηχανισμός 3/4" for brass stop valve 3/4"	40006	3800154007866	18/216	5,27
Μηχανισμός 1" for brass stop valve 1"	40009	3800154018978	10/120	4,87



THS
THERMOSTYLE



ΣΦΑΙΡΙΚΟΙ ΔΙΑΚΟΠΤΕΣ ΟΡΕΙΧΑΛΚΙΝΟΙ

BRASS BALL VALVES

ΣΦΑΙΡΙΚΟΣ ΔΙΑΚΟΠΤΗΣ Θ-Θ ΜΕ ΠΑΞΙΜΑΔΙ ΑΣΦΑΛΕΙΑΣ
BRASS BALL VALVE FF LONG HANDLE WITH PRESS NUT UNDER THE HANDLE



ΔΙΑΣΤΑΣΗ Dimension	ΚΩΔΙΚΟΣ Item №	Barcode		ΤΙΜΗ
1/2"	4020	3800154007965	12/144	4,69
3/4"	4021	3800154007972	10/120	6,47
1"	4022	3800154007989	6/72	9,09
1 1/4"	4023	3800154007996	6/36	15,33
1 1/2"	4024	3800154008009	4/24	24,37
2"	4025	3800154008016	2/12	39,33
2 1/2"	474	3800154023569	2/8	99,98
3"	480	3800154022302	2/8	148,48
4"	481	3800154024559	2/4	162,44

ΣΦΑΙΡΙΚΟΣ ΔΙΑΚΟΠΤΗΣ Θ-Θ ΜΕ ΕΞΑΕΡΙΣΤΙΚΟ
BRASS BALL SEWAGE VALVE FF LONG HANDLE WITH PRESS NUT UNDER THE HANDLE



ΔΙΑΣΤΑΣΗ Dimension	ΚΩΔΙΚΟΣ Item №	Barcode		ΤΙΜΗ
1/2"	26	3800154008023	5/60	7,57
3/4"	27	3800154008030	6/72	9,38
1"	271	3800154008047	6/48	11,95
1 1/4"	28	3800154008054	6/36	13,44
1 1/2"	29	3800154008061	4/24	35,97
2"	30	3800154008078	2/12	47,19

ΣΦΑΙΡΙΚΟΣ ΔΙΑΚΟΠΤΗΣ Α-Θ ΜΑΚΡΙΑ ΛΑΒΗ
BRASS BALL VALVE FM LONG HANDLE



ΔΙΑΣΤΑΣΗ Dimension	ΚΩΔΙΚΟΣ Item №	Barcode		ΤΙΜΗ
1/2"	193	3800154008085	12/144	5,03
3/4"	194	3800154018572	10/120	6,86
1"	1941	3800154018589	6/72	10,85
1 1/4"	4014	3800154008153	3/36	17,11
1 1/2"	4015	3800154008160	4/24	28,92
2"	4016	3800154008177	2/12	38,96

ΕΞΑΕΡΙΣΤΙΚΟ ΣΦΑΙΡΙΚΟΥ ΔΙΑΚΟΠΤΗ
SEWAGE END FOR BALL VALVE



ΔΙΑΣΤΑΣΗ Dimension	ΚΩΔΙΚΟΣ Item №	Barcode		ΤΙΜΗ
1/4"	4018	3800154008474	10/1000	1,26

ΣΦΑΙΡΙΚΟΙ ΔΙΑΚΟΠΤΕΣ ΟΡΕΙΧΑΛΚΙΝΟΙ BRASS BALL VALVES

ΣΦΑΙΡΙΚΟΣ ΔΙΑΚΟΠΤΗΣ Θ-Θ ΜΕ ΠΑΞΙΜΑΔΙ
BRASS BALL VALVE FF BUTTERFLY HANDLE WITH PRESS NUT UNDER THE HANDLE



ΔΙΑΣΤΑΣΗ Dimension	ΚΩΔΙΚΟΣ Item №	Barcode		ΤΙΜΗ
1/2"	4004	3800154008092	19/228	4,82
3/4"	4005	3800154008108	14/168	6,21
1"	4006	3800154008115	10/120	9,62

ΣΦΑΙΡΙΚΟΣ ΔΙΑΚΟΠΤΗΣ Α-Θ ΜΕ ΠΑΞΙΜΑΔΙ
BRASS BALL VALVE FM BUTTERFLY HANDLE WITH PRESS NUT UNDER THE HANDLE



ΔΙΑΣΤΑΣΗ Dimension	ΚΩΔΙΚΟΣ Item №	Barcode		ΤΙΜΗ
1/2"	4007	3800154008122	19/228	4,79
3/4"	4008	3800154008139	14/168	6,63
1"	4009	3800154008146	10/120	10,01

ΣΦΑΙΡΙΚΟΣ ΔΙΑΚΟΠΤΗΣ ΜΕ ΡΑΚΟΡ ΚΑΙ ΠΑΞΙΜΑΔΙ
BRASS BALL VALVE STRAIGHT WITH UNION BUTTERFLY HANDLE WITH PRESS NUT



ΔΙΑΣΤΑΣΗ Dimension	ΚΩΔΙΚΟΣ Item №	Barcode		ΤΙΜΗ
1/2"	4010	3800154008184	12/144	7,07
3/4"	4011	3800154008191	10/120	10,64
1"	4012	3800154008207	5/60	14,67
1 1/4"	1703	3800154008214	3/12	31,02

ΣΦΑΙΡΙΚΟΣ ΔΙΑΚΟΠΤΗΣ ΜΕ ΤΡΕΛΟ ΡΑΚΟΡ Θ-Θ
BRASS BALL VALVE WITH NUT FF BUTTERFLY HANDLE AND PRESS NUT



ΔΙΑΣΤΑΣΗ Dimension	ΚΩΔΙΚΟΣ Item №	Barcode		ΤΙΜΗ
1/2"	7738	3800154031397	12/144	8,38
3/4"	7739	3800154031403	10/120	11,40
1"	7740	3800154031410	5/60	18,08

ΣΦΑΙΡΙΚΟΣ ΔΙΑΚΟΠΤΗΣ ΠΕΤΑΛΟΥΔΑ Α-Α
BRASS BALL VALVE MM BUTTERFLY HANDLE AND PRESS NUT UNDER THE HANDLE



ΔΙΑΣΤΑΣΗ Dimension	ΚΩΔΙΚΟΣ Item №	Barcode		ΤΙΜΗ
1/2"	7735	3800154031366	19/228	4,90
3/4"	7736	3800154031373	14/168	7,23
1"	7737	3800154031380	10/120	11,40

ΣΦΑΙΡΙΚΟΣ ΓΩΝΙΑΚΟΣ ΔΙΑΚΟΠΤΗΣ ΜΕ ΡΑΚΟΡ
BRASS ANGLE BALL VALVE WITH UNION BUTTERFLY HANDLE WITH PRESS NUT



ΔΙΑΣΤΑΣΗ Dimension	ΚΩΔΙΚΟΣ Item №	Barcode		ΤΙΜΗ
1/2"	412	3800154008221	12/144	8,62
3/4"	413	3800154008238	8/96	11,14
1"	414	3800154008245	7/42	18,76

TMS
THERMOSTYLE









ΔΙΑΚΟΠΤΕΣ ΜΙΝΙ ΣΦΑΙΡΙΚΟΙ ΟΡΕΙΧΑΛΚΙΝΟΙ

MINI BRASS BALL VALVES

ΜΙΝΙ ΣΦΑΙΡΙΚΟΣ ΔΙΑΚΟΠΤΗΣ ΝΙΚΕΛ Α-Θ

MINI BRASS BALL VALVE NICKEL PLATED FM





	ΚΩΔΙΚΟΣ Item №	Barcode		ΤΙΜΗ
3/8" ΜΠΛΕ ΧΕΡΟΥΛΙ 3/8" BLUE HANDLE	420	3800154017100		3,64
3/8" ΚΟΚΚΙΝΟ ΧΕΡΟΥΛΙ	4201	3800154017117		3,64
1/2" ΜΠΛΕ ΧΕΡΟΥΛΙ 1/2" BLUE HANDLE	41	3800154008382		3,56
1/2" ΚΟΚΚΙΝΟ ΧΕΡΟΥΛΙ	42	3800154008399		3,56
3/4" ΚΟΚΚΙΝΟ ΧΕΡΟΥΛΙ	424	3800154008405		4,53

ΜΙΝΙ ΣΦΑΙΡΙΚΟΣ ΔΙΑΚΟΠΤΗΣ ΝΙΚΕΛ Θ-Θ

MINI BRASS BALL VALVE NICKEL PLATED FF





ΔΙΑΣΤΑΣΗ Dimension	ΚΩΔΙΚΟΣ Item №	Barcode		ΤΙΜΗ
3/8" ΜΠΛΕ ΧΕΡΟΥΛΙ 3/8" BLUE HANDLE	43	3800154017087		3,64
3/8" ΚΟΚΚΙΝΟ ΧΕΡΟΥΛΙ 3/8" RED HANDLE	4301	3800154017094		3,64

ΜΙΝΙ ΣΦΑΙΡΙΚΟΣ ΔΙΑΚΟΠΤΗΣ ΧΡΩΜΙΟ Α-Α

MINI BRASS BALL VALVE CHROME PLATED FM





	ΚΩΔΙΚΟΣ Item №	Barcode		ΤΙΜΗ
1/2" ΜΠΛΕ ΧΕΡΟΥΛΙ 1/2" BLUE HANDLE	431	3800154008368		4,09
1/2" ΚΟΚΚΙΝΟ ΧΕΡΟΥΛΙ 1/2" RED HANDLE	432	3800154008375		4,09

ΜΙΝΙ ΣΦΑΙΡΙΚΟΣ ΔΙΑΚΟΠΤΗΣ ΧΡΩΜΙΟ Θ-Θ

MINI BRASS BALL VALVE CHROME PLATED FF





ΔΙΑΣΤΑΣΗ Dimension	ΚΩΔΙΚΟΣ Item №	Barcode		ΤΙΜΗ
1/2" ΜΠΛΕ ΧΕΡΟΥΛΙ 1/2" BLUE HANDLE	4231	3800154017049		4,19
1/2" ΚΟΚΚΙΝΟ ΧΕΡΟΥΛΙ 1/2" RED HANDLE	4232	3800154017056		4,19

ΜΙΝΙ ΣΦΑΙΡΙΚΟΣ ΔΙΑΚΟΠΤΗΣ ΧΡΩΜΙΟ Α-Α

MINI BRASS BALL VALVE CHROME PLATED MM



ΔΙΑΣΤΑΣΗ Dimension	ΚΩΔΙΚΟΣ Item №	Barcode		ΤΙΜΗ
1/2" ΚΟΚΚΙΝΟ ΧΕΡΟΥΛΙ 1/2" RED HANDLE	419	3800154017124		3,85

TMS[®]
THERMOSTYLE



ΔΙΑΚΟΠΤΕΣ ΜΙΝΙ ΣΦΑΙΡΙΚΟΙ ΟΡΕΙΧΑΛΚΙΝΟΙ Β.Τ. MINI BRASS BALL VALVES

ΒΑΝΑ Θ-Θ ΧΕΡΟΥΛΙ Β.Τ.

BRASS BALL VALVE FULL PORT FF LONG HANDLE WITH PRESS NUT UNDER THE HANDLE



ΔΙΑΣΤΑΣΗ Dimension	ΚΩΔΙΚΟΣ Item №	Barcode		ΤΙΜΗ
1/2"	100182	3800154054433	12/144	5,34
3/4"	100183	3800154054471	10/120	8,52
1"	100184	3800154054518	6/72	12,16
1 1/4"	100364	3800154058400	4/24	21,35
1 1/2"	100365	3800154058448	4/16	34,06
2"	100366	3800154058486	2/10	44,49

ΒΑΝΑ Α-Θ ΧΕΡΟΥΛΙ Β.Τ.

BRASS BALL VALVE FULL PORT FM LONG HANDLE WITH PRESS NUT UNDER THE HANDLE



ΔΙΑΣΤΑΣΗ Dimension	ΚΩΔΙΚΟΣ Item №	Barcode		ΤΙΜΗ
1/2"	100185	3800154054556	12/144	5,69
3/4"	100186	3800154054594	10/120	8,78
1"	100187	3800154054631	6/72	13,99
1 1/4"	100 396	3800154058691	4/24	21,56
1 1/2"	100 397	3800154058738	4/16	35,11
2"	100 398	3800154058776	2/10	46,32

ΒΑΝΑ Θ-Θ ΠΕΤΑΛΟΥΔΑ Β.Τ.

BRASS BALL VALVE FULL PORT FF LONG HANDLE WITH PRESS NUT UNDER THE HANDLE



ΔΙΑΣΤΑΣΗ Dimension	ΚΩΔΙΚΟΣ Item №	Barcode		ΤΙΜΗ
1/2"	100 358	3800154058523	20/100	5,16
3/4"	100 359	3800154058561	16/80	8,25
1"	100 360	3800154058608	16/64	12,94

ΒΑΝΑ Α-Θ ΠΕΤΑΛΟΥΔΑ Β.Τ.

BRASS BALL VALVE FULL PORT FM LONG HANDLE WITH PRESS NUT UNDER THE HANDLE



ΔΙΑΣΤΑΣΗ Dimension	ΚΩΔΙΚΟΣ Item №	Barcode		ΤΙΜΗ
1/2"	100 361	3800154058288	20/100	5,34
3/4"	100 362	3800154058325	16/80	8,46
1"	100 363	3800154058363	16/64	13,60

ΒΑΝΑ Θ-Θ ΧΕΡΟΥΛΙ Β.Τ. ΜΕ ΦΙΛΤΡΟ

BRASS BALL VALVE WITH FILTER WITH PRESS NUT UNDER THE HANDLE



ΔΙΑΣΤΑΣΗ Dimension	ΚΩΔΙΚΟΣ Item №	Barcode		ΤΙΜΗ
1/2"	44	38001540546938	/96	7,10
3/4"	45	38001540547616	/72	9,67
1"	46	3800154054792	4/48	13,60

THS[®]
THERMOSTYLE





ΓΩΝΙΑΚΑ ΔΙΑΚΟΠΤΑΚΙΑ ΟΡΕΙΧΑΛΚΙΝΑ

BRASS ANGLE VALVES

ΟΡΕΙΧΑΛΚΙΝΟ ΕΠΙΧΡΩΜΙΩΜΕΝΟ ΓΩΝΙΑΚΟ ΔΙΑΚΟΠΤΑΚΙ ΣΦΑΙΡΙΚΟ ΜΕ ΡΟΖΕΤΑ ΚΑΙ ΜΕΤΑΛΛΙΚΟ ΧΕΡΟΥΛΙ

BRASS CHROME PLATED ANGLE BALL VALVE METAL HANDLE



ΔΙΑΣΤΑΣΗ Dimension	ΚΩΔΙΚΟΣ Item N°	Barcode		ΤΙΜΗ
1/2" * 3/8"	4047	3800154015519	1/100	6,45
1/2" * 1/2"	4094	3800154015502	1/100	6,45
1/2" * 3/4"	4028	3800154015526	1/100	6,94

ΟΡΕΙΧΑΛΚΙΝΟ ΕΠΙΧΡΩΜΙΩΜΕΝΟ ΓΩΝΙΑΚΟ ΔΙΑΚΟΠΤΑΚΙ ΣΦΑΙΡΙΚΟ ΜΕ ΦΙΛΤΡΟ, ΡΟΖΕΤΑ ΚΑΙ ΜΕΤΑΛΛΙΚΟ ΧΕΡΟΥΛΙ

BRASS CHROME PLATED ANGLE BALL VALVE WITH STRAINER AND METAL HANDLE



ΔΙΑΣΤΑΣΗ Dimension	ΚΩΔΙΚΟΣ Item N°	Barcode		ΤΙΜΗ
1/2" * 3/8"	460	3800154008313	1/100	6,42
1/2" * 1/2"	435	3800154008306	1/100	6,42
1/2" * 3/4"	433	3800154008320	1/100	6,42

ΟΡΕΙΧΑΛΚΙΝΟ ΓΩΝΙΑΚΟ ΔΙΑΚΟΠΤΑΚΙ ΠΕΡΙΣΤΡΟΦΙΚΟ ΕΠΙΧΡΩΜΙΩΜΕΝΟ

BRASS CHROME PLATED ANGLE STOP VALVE



ΔΙΑΣΤΑΣΗ Dimension	ΚΩΔΙΚΟΣ Item N°	Barcode		ΤΙΜΗ
1/2" * 3/8"	425	3800154008252	1/200	6,10
1/2" * 1/2"	4072	3800154008269	1/200	6,10

ΟΡΕΙΧΑΛΚΙΝΟ ΓΩΝΙΑΚΟ ΔΙΑΚΟΠΤΑΚΙ ΣΦΑΙΡΙΚΟ ΕΠΙΧΡΩΜΙΩΜΕΝΟ

BRASS ANGLE STOP VALVE PLATINIUM TURPEDO



ΔΙΑΣΤΑΣΗ Dimension	ΚΩΔΙΚΟΣ Item N°	Barcode		ΤΙΜΗ
1/2" * 3/8"	4074	3800154022111	1/100	6,81
1/2" * 1/2"	4075	3800154022128	1/100	6,81
1/2" * 3/4"	4076	3800154022135	1/100	6,81

ΟΡΕΙΧΑΛΚΙΝΟ ΔΙΑΚΟΠΤΑΚΙ ΠΛΥΝΤΗΡΙΟΥ ΜΕ ΕΠΙΧΡΩΜΙΩΜΕΝΗ ΣΩΛΗΝΑ

BRASS VALVE FOR WASHING MACHINE PIPE CHROME PLATED

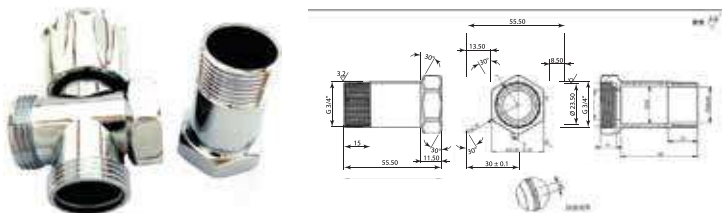

ΔΙΑΣΤΑΣΗ Dimension	ΚΩΔΙΚΟΣ Item N°	Barcode		ΤΙΜΗ
3/4"	5909	3800154022289	1/96	10,93

ΟΡΕΙΧΑΛΚΙΝΟ ΕΠΙΧΡΩΜΙΩΜΕΝΟ ΤΑΥ ΜΕ ΔΙΑΚΟΠΤΗ

BRASS TEE ANGLE VALVE 3 WAYS CHROME PLATED



ΔΙΑΣΤΑΣΗ Dimension	ΚΩΔΙΚΟΣ Item N°	Barcode		ΤΙΜΗ
1/2"A*3/4"A*1/2"Θ 1/2"M*3/4"M*1/2"F	437	3800154008337	1/100	5,50

TMS
THERMOSTYLE



ΓΩΝΙΑΚΑ ΔΙΑΚΟΠΤΑΚΙΑ ΟΡΕΙΧΑΛΚΙΝΑ

BRASS ANGLE VALVES

ΓΩΝΙΑΚΟ ΔΙΑΚΟΠΤΑΚΙ ΜΕ ΦΙΛΤΡΟ

BRASS ANGLE STOP VALVE WITH FILTER TOP



ΔΙΑΣΤΑΣΗ Dimension	ΚΩΔΙΚΟΣ Item N°	Barcode		ΤΙΜΗ
1/2" * 3/8"	8983	3800154033117	1/80	15,12
1/2" * 1/2"	8984	3800154033124	1/80	14,93
1/2" * 3/4"	8985	3800154033131	1/80	15,46

ΓΩΝΙΑΚΟ ΔΙΑΚΟΠΤΑΚΙ

BRASS ANGLE STOP VALVE OVAL



ΔΙΑΣΤΑΣΗ Dimension	ΚΩΔΙΚΟΣ Item N°	Barcode		ΤΙΜΗ
1/2" * 1/2" CHROME	9978	3800154004285	1/80	14,20
1/2" * 1/2" BLACK	9979	3800154004292	1/80	17,58

ΓΩΝΙΑΚΟ ΔΙΑΚΟΠΤΑΚΙ ΣΕΙΡΑ ROSE

BRASS STOP VALVE SERIES ROSE



ΔΙΑΣΤΑΣΗ Dimension	ΚΩΔΙΚΟΣ Item N°	Barcode		ΤΙΜΗ
1/2" * 1/2"	10006	3800154040580	1/200	21,43

THS[®]
THERMOSTYLE



ΓΩΝΙΑΚΑ ΔΙΑΚΟΠΤΑΚΙΑ ΟΡΕΙΧΑΛΚΙΝΑ Β.Τ.
BRASS ANGLE VALVES

Серия **TOP** и **SHARP**

ΓΩΝΙΑΚΟ ΔΙΑΚΟΠΤΑΚΙ ΧΡΩΜΕ ΜΕ ANTI-SCRATCH ΡΟΖΕΤΑ TOP SILVER
 BRASS ANGLE VALVE WITH ANTI-SCRATCH ROSETTE TOP SILVER

Ø 10 mm



ΔΙΑΣΤΑΣΗ Dimension	ΚΩΔΙΚΟΣ Item №	Barcode		ΤΙΜΗ
1/2" * 3/8" με παξιμάδι Ø 10 mm	4090	3800154022326	1/80	9,80

ΓΩΝΙΑΚΟ ΔΙΑΚΟΠΤΑΚΙ ΧΡΥΣΟ ΜΕ ANTI-SCRATCH ΡΟΖΕΤΑ TOP GOLD
 BRASS ANGLE VALVE WITH ANTI-SCRATCH ROSETTE TOP GOLD

Ø 10 mm



ΔΙΑΣΤΑΣΗ Dimension	ΚΩΔΙΚΟΣ Item №	Barcode		ΤΙΜΗ
1/2" * 3/8" με παξιμάδι Ø 10 mm 1/2" * 3/8" WITH NUT Ø 10 mm	40901	3800154023842	1/80	10,58



ΓΩΝΙΑΚΑ ΔΙΑΚΟΠΤΑΚΙΑ ΟΡΕΙΧΑΛΚΙΝΑ Β.Τ. BRASS ANGLE VALVES

ΕΠΙΛΟΓΕΣ ΕΓΚΑΤΑΣΤΑΣΗΣ POSSIBLE INSTALLATION OPTIONS

- ➔ Τοποθέτηση με εύκαμπτο σπирάή M10x1
Installation with flexible hose M10x1







- ➔ Τοποθέτηση με σωληνάκι Ø 10 mm
Installation with pipe Ø 10 mm









ΕΠΙΧΡΩΜΙΩΜΕΝΟ ΣΩΛΗΝΑΚΙ CU Ø10 ΓΙΑ ΝΙΠΤΗΡΑ
CHROME PLATED CU PIPE Ø 10 mm FOR WASH BASIN









ΔΙΑΣΤΑΣΗ Dimension	ΚΩΔΙΚΟΣ Item №	Barcode	 	ΤΙΜΗ
Ø 10 * 50 cm	6774	3800154028410	 	7,21

ΕΠΙΧΡΩΜΙΩΜΕΝΟ ΣΩΛΗΝΑΚΙ CU Ø10 ΜΕ ΠΑΞΙΜΑΔΙ
CHROME PLATED CU PIPE Ø 10 mm WITH BRASS NUT



ΔΙΑΣΤΑΣΗ Dimension	ΚΩΔΙΚΟΣ Item №	Barcode	 	ΤΙΜΗ
3/8" * 40 cm	6770	3800154028373	 	7,26
3/8" * 100 cm	6771	3800154028380	 	13,55



ΔΙΑΣΤΑΣΗ Dimension	ΚΩΔΙΚΟΣ Item №	Barcode	 	ΤΙΜΗ
1/2" * 40 cm	6772	3800154028397	 	7,02
1/2" * 100 cm	6773	3800154028403	 	13,20



TMS[®]
THERMOSTYLE



ΓΩΝΙΑΚΑ ΔΙΑΚΟΠΤΑΚΙΑ ΟΡΕΙΧΑΛΚΙΝΑ Β.Τ. BRASS ANGLE VALVES

ΞΕΡΤΗΜΑΤΑ ΓΙΑ ΓΩΝΙΑΚΑ ΔΙΑΚΟΠΤΑΚΙΑ SPARE PARTS FOR BRASS ANGLE VALVES TOP

ΚΩΔΙΚΟΣ Item N°	ΦΩΤΟ N° from the scheme	ΟΝΟΜΑ & ΔΙΑΣΤΑΣΗ Name and dimension	Barcode		ΤΙΜΗ
9502	(2)	Μηχανισμός κλεισίματος για διακόπτη TOP SILVER/GOLD CARTAGE FOR STOP VALVE TOP SILVER/GOLD	3800154023910	-	3,28
40904	(3)	Τάπα THS βαλβίδας TOP SILVER CAP THS FOR STOP VALVE TOP SILVER	3800154023934	-	2,59
9506	(4)	Φλάντζα με ορειχ/νο O-RING Ø10 για διακόπτη TOP SILVER/GOLD BARSS PART WITH O-RING 10 mm FOR STOP VALVE TOP SILVER/GOLD	3800154023972	-	0,29
9504	(5)	Ορειχάλκινα εξαρτήματα 3/8" Ø10 για διακόπτη TOP SILVER 3/8" * 10 mm SILVER FOR STOP VALVE TOP SILVER	3800154023958	-	1,23
9505	(5)	Ορειχάλκινα εξαρτήματα 3/8" Ø10 για διακόπτη TOP GOLD 3/8" * 10 mm GOLD FOR STOP VALVE TOP GOLD	3800154023965	-	1,52
40902	(6)	Τάπα με σπή για διακόπτη TOP SILVER HOLE FOR STOP VALVE TOP SILVER	3800154023897	-	1,26
9500	(7)	Ροζέτα ορειχάλκινη 1/2" με Anti-Scratch TOP SILVER ROSETTE 1/2" WITH ANTI-SCRATCH SEAL TOP SILVER	3800154023873	1/200	2,10
9501	(7)	Ροζέτα ορειχάλκινη 1/2" με Anti-Scratch TOP GOLD ROSETTE 1/2" WITH ANTI-SCRATCH SEAL TOP GOLD	3800154023880	1/200	2,44
9503	(7)	Anti-Scratch λάστιχο ροζέτας TOP SILVER/GOLD SCRATCH SEAL TOP SILVER/GOLD	ANTI- 3800154023927	-	0,16

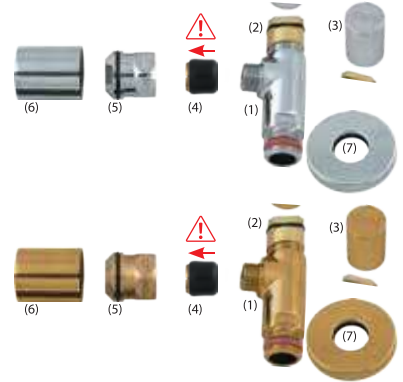

ΟΔΗΓΙΕΣ ΕΓΚΑΤΑΣΤΑΣΗΣ

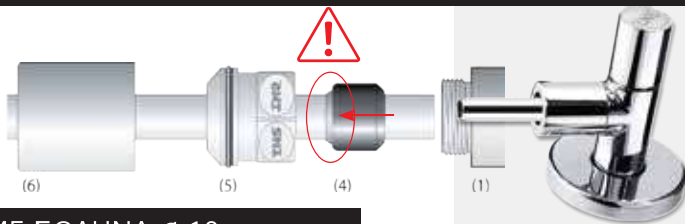

ΜΕ ΣΩΛΗΝΑ Ø 10 mm :

1. Περάστε τον σωλήνα μέσα από την τάπα (6)
2. Τοποθετείστε τον ορειχάλκινο αντάπτορα 3/8" x Ø10(5), ακολουθώντας την κατεύθυνση, όπως δείχνει το σχεδιάγραμμα
3. Τοποθετείστε τη φλάντζα με ορειχ/νο O-RING για Ø10(4) όπως υποδεικνύεται στο σχεδιάγραμμα. Το ορειχάλκινο μέρος πρέπει να είναι προς το ορειχάλκινο αντάπτη 3/8" x Ø10(4).
4. Συνδέστε τον σωλήνα προς το αρσενικό σπείρωμα του διακόπτη(1).
5. Βεβαιωθείτε ότι ο σωλήνας είναι σφικτά στερεωμένος στον διακόπτη πριν βιδώσετε.
6. Βιδώστε το ορειχ/νο αντάπτη 3/8" x Ø10(5) με κλειδί Νο19 προς το αρσενικό σπείρωμα του διακόπτη(1) και τοποθετήστε την διακοσμητική τάπα με σπή(6) πάνω στο ορειχάλκινο αντάπτη 3/8" x Ø10(5). Χρησιμοποιήστε μόνο τα κατάλληλα εργαλεία.

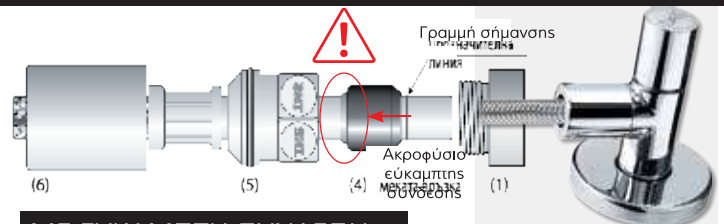

ΜΕ ΕΥΚΑΜΠΤΗ ΣΥΝΔΕΣΗ:

1. Περάστε τον εύκαμπτο σύνδεσμο μέσα από την τάπα(6)
2. Τοποθετείστε τον ορειχάλκινο αντάπτορα 3/8" x Ø10(5), ακολουθώντας την κατεύθυνση, όπως δείχνει το σχεδιάγραμμα
3. Τοποθετείστε τη φλάντζα με ορειχ/νο O-RING για Ø10(4) όπως υποδεικνύεται στο σχεδιάγραμμα. Το ορειχάλκινο μέρος πρέπει να είναι προς το ορειχάλκινο αντάπτη 3/8" x Ø10(4). Αν το ακροφύσιο του εύκαμπτου συνδέσμου έχει γραμμή σήμανσης, βεβαιωθείτε ότι η φλάντζα με ορειχ/νο O-RING για Ø10(4) είναι πίσω από τη γραμμή σήμανσης, όπως στο σχεδιάγραμμα.
4. Συνδέστε τον εύκαμπτο σύνδεσμο στο αρσενικό σπείρωμα του διακόπτη(1).
5. Βεβαιωθείτε ότι ο εύκαμπτος σύνδεσμος είναι σφικτά στερεωμένος στον διακόπτη πριν βιδώσετε.
6. Βιδώστε το ορειχ/νο αντάπτη 3/8" x Ø10(5) με κλειδί Νο19 και τοποθετήστε την διακοσμητική τάπα με σπή(6) πάνω στο ορειχάλκινο αντάπτη 3/8" x Ø10(5). Χρησιμοποιήστε μόνο τα κατάλληλα εργαλεία.

INSTRUCTION OF INSTALATION

WITH PIPE Ø 10 mm:

1. Pass the pipe through the cap. (6)
2. Install the brass adapter 3/8" x Ø10 (5) as it's shown on the diagram above.
3. Place the brass O-ring seal for Ø10 (4) in the manner shown in the diagram. The brass part should be in the direction to the brass adapter 3/8" x Ø10 (4).
4. Connect the pipe to the male thread on the tap (1).
5. Before you begin the tightening, make sure the pipe is tightly attached to the crane.
6. Screw the brass adapter 3/8" x Ø10 (5) to the male thread on the tap and place the decorative cap with an opening (6) on the brass adapter, use appropriate professional tools for this.

WITH FLEXIBLE HOSE:

1. Pass the flexible hose through the cap with an opening (6).
2. Install the brass adapter 3/8" x Ø10 (5) as it's shown on the diagram above.
3. Place the brass O-ring seal for Ø10 (4) in the manner shown in the diagram. The brass part should be in the direction to the brass adapter 3/8" x Ø10 (4). If there is a designating line on the end of the flexible hose, make sure that the brass O-ring seal for Ø10 is behind the designating line as shown in the diagram above.
4. Connect the flexible hose to the male thread on the tap (1).
5. Before you begin the tightening, make sure the pipe is tightly attached to the crane.
6. Screw the brass adapter 3/8" x Ø10 (5) to the male thread on the hose and place the decorative cap with an opening (6) on the brass adapter, use appropriate professional tools for this.



ΓΩΝΙΑΚΑ ΔΙΑΚΟΠΤΑΚΙΑ BRASS ANGLE VALVES

ΟΡΕΙΧΑΛΚΙΝΟ ΓΩΝΙΑΚΟ ΔΙΑΚΟΠΤΑΚΙ ΠΕΡΙΣΤΡΟΦΙΚΟ
ΜΕ ΡΟΖΕΤΑ ANTI-SCRATCH, TOP SILVER
BRASS ANGLE VALVE WITH ANTI-SCRATCH ROSETTE TOP SILVER



ΟΡΕΙΧΑΛΚΙΝΟ ΓΩΝΙΑΚΟ ΔΙΑΚΟΠΤΑΚΙ ΠΕΡΙΣΤΡΟΦΙΚΟ
ΜΕ ΡΟΖΕΤΑ ANTI-SCRATCH, TOP GOLD
BRASS ANGLE VALVE WITH ANTI-SCRATCH ROSETTE TOP GOLD



ΔΙΑΣΤΑΣΗ Dimension	ΚΩΔΙΚΟΣ Item №	Barcode		ΤΙΜΗ
1/2" * 3/8"	4091	3800154022319	1/80	10,58
1/2" * 1/2"	4092	3800154022333	1/80	10,74
1/2" * 3/4"	4093	3800154022340	1/80	11,14

ΔΙΑΣΤΑΣΗ Dimension	ΚΩΔΙΚΟΣ Item №	Barcode		ΤΙΜΗ
1/2" * 3/8"	40911	3800154023835	1/80	9,17
1/2" * 1/2"	40921	3800154023859	1/80	9,30
1/2" * 3/4"	40931	3800154023866	1/80	9,51

ΟΡΕΙΧΑΛΚΙΝΟ ΓΩΝΙΑΚΟ ΔΙΑΚΟΠΤΑΚΙ ΣΦΑΙΡΙΚΟ
ΜΕ ΡΟΖΕΤΑ SHARP SILVER
BRASS ANGLE VALVE SHARP SILVER



Το σετ περιλαμβάνει ταινία τεφλόν
The set includes PTFE

ΟΡΕΙΧΑΛΚΙΝΟ ΓΩΝΙΑΚΟ ΔΙΑΚΟΠΤΑΚΙ ΣΦΑΙΡΙΚΟ
ΜΕ ΡΟΖΕΤΑ SHARP GOLD
BRASS ANGLE VALVE SHARP GOLD



ΔΙΑΣΤΑΣΗ Dimension	ΚΩΔΙΚΟΣ Item №	Barcode		ΤΙΜΗ
1/2" * 3/8"	4031	3800154024009	1/100	11,76
1/2" * 1/2"	4032	3800154023989	1/100	12,10
1/2" * 3/4"	4033	3800154024023	1/100	12,45

ΔΙΑΣΤΑΣΗ Dimension	ΚΩΔΙΚΟΣ Item №	Barcode		ΤΙΜΗ
1/2" * 3/8"	40311	3800154024016	1/100	7,21
1/2" * 1/2"	40321	3800154023996	1/100	7,36
1/2" * 3/4"	40331	3800154024030	1/100	7,52

THS[®]
THERMOSTYLE



ΓΩΝΙΑΚΑ ΔΙΑΚΟΠΤΑΚΙΑ BRASS ANGLE VALVES

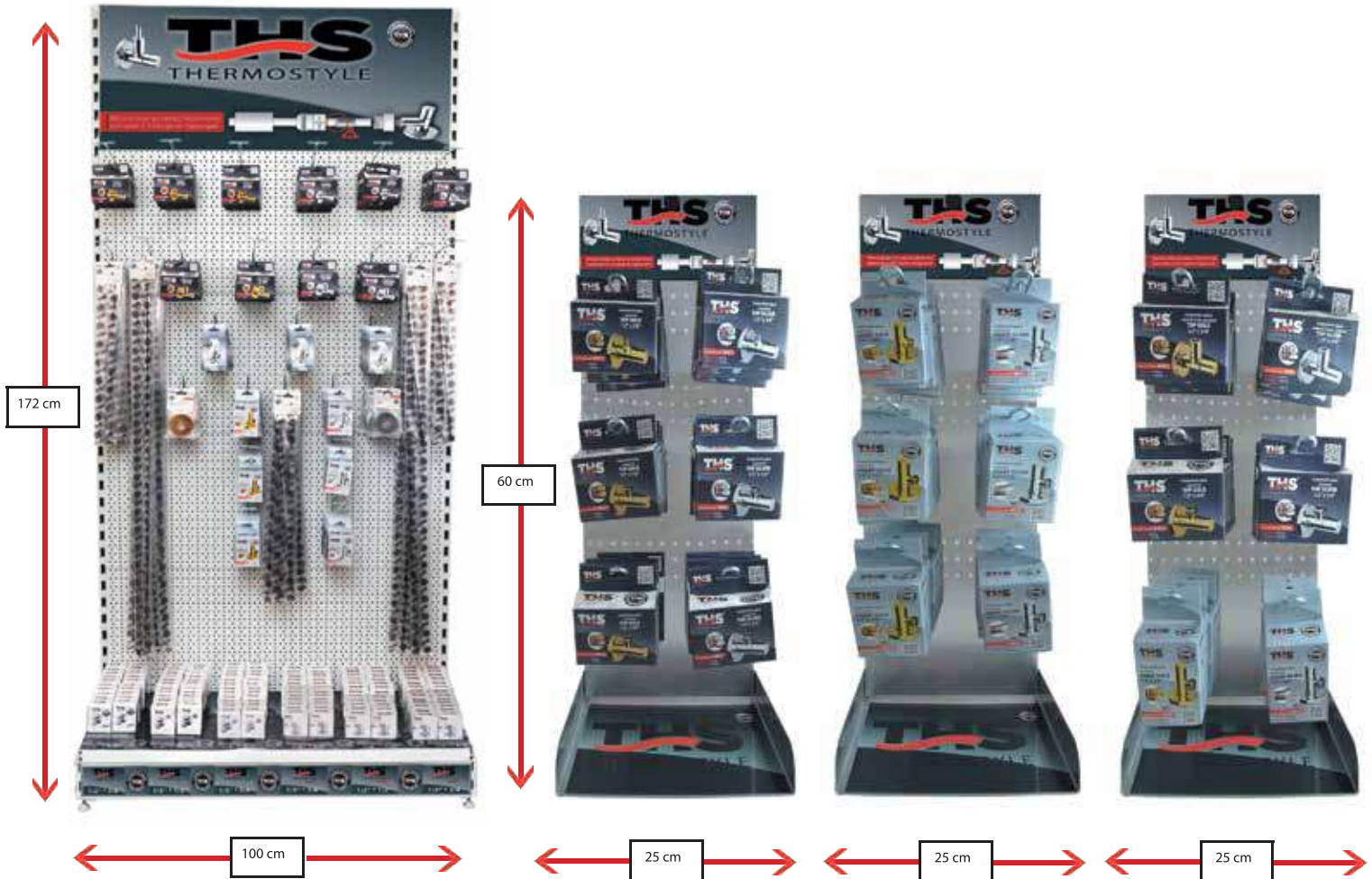

ΒΑΛΒΙΔΕΣ ΟΡ/ΝΕΣ ΑΝΤΕΠΙΣΤΡΟΦΗΣ BRASS WATER SUPPLY ARMATURE

ΒΑΛΒΙΔΑ ΕΛΑΤΗΡΙΟΥ ΜΕ ΠΛΑΣΤΙΚΟ ΔΙΣΚΟ BRASS CHECK VALVE PLASTIC DISC



ΔΙΑΣΤΑΣΗ Dimension	ΚΩΔΙΚΟΣ Item N°	Barcode		ΤΙΜΗ
1/2"	51	3800154008481	32/384	3,20
3/4"	52	3800154008498	12/144	5,19
1"	53	3800154008504	10/120	5,71
1 1/4"	54	3800154008511	6/72	11,69
1 1/2"	55	3800154008528	6/72	17,92
2"	56	3800154008535	5/60	24,79

ΚΛΑΠΕ BRASS CHECK VALVE HORIZONTAL INSTALLATION WITH BRASS DISC



ΔΙΑΣΤΑΣΗ Dimension	ΚΩΔΙΚΟΣ Item N°	Barcode		ΤΙΜΗ
1/2"	510	3800154016295	16/160	4,38
3/4"	511	3800154016301	10/100	4,69
1"	512	3800154016318	8/64	10,45
1 1/4"	513	3800154016325	6/48	15,77
1 1/2"	514	3800154016332	5/40	21,27
2"	515	3800154016349	2/16	32,65

ΒΑΛΒΙΔΑ ΕΛΑΤΗΡΙΟΥ ΜΕ ΟΡΕΙΧ/ΝΟ ΔΙΣΚΟ BRASS CHECK VALVE WITH BRASS DISC



ΔΙΑΣΤΑΣΗ Dimension	ΚΩΔΙΚΟΣ Item N°	Barcode		ΤΙΜΗ
1/2"	5111	3800154018985	16/192	3,83
3/4"	5112	3800154018992	12/144	5,11
1"	5113	3800154019005	9/108	7,07
1 1/4"	5114	3800154019012	6/72	15,01
1 1/2"	5115	3800154019029	6/36	22,17
2"	5116	3800154019036	3/18	27,12
2 1/2"	5118	3800154025129	3/12	63,12
3"	5119	3800154025136	3/12	69,43
4"	5120	3800154025143	1/6	125,26

ΒΑΛΒΙΔΑ ΕΛΑΤΗΡΙΟΥ ΜΕ ΦΙΛΤΡΟ BRASS CHECK VALVE WITH SCREEN



ΔΙΑΣΤΑΣΗ Dimension	ΚΩΔΙΚΟΣ Item N°	Barcode		ΤΙΜΗ
1/2"	615	3800154008542	18/144	3,20
3/4"	69	3800154008559	18/108	4,59
1"	610	3800154008566	12/72	6,03
1 1/4"	611	3800154008573	4/42	8,23
1 1/2"	612	3800154008580	4/36	12,39
2"	613	3800154008597	3/27	18,79

ΠΟΤΗΡΙ ΠΥΘΜΕΝΟΣ ΟΒΑΛ BRASS CHECK VALVE WITH BRASS SCREEN



ΔΙΑΣΤΑΣΗ Dimension	ΚΩΔΙΚΟΣ Item N°	Barcode		ΤΙΜΗ
3/4"	61	3800154016356	10/120	5,21
1"	62	3800154016363	12/144	9,56
1 1/4"	63	3800154016370	3/30	11,42
1 1/2"	64	3800154016387	4/42	13,83
2"	65	3800154016394	2/20	20,96



ΟΡΕΙΧΑΛΚΙΝΑ ΕΞΑΡΤΗΜΑΤΑ BRASS WATER SUPPLY ARMATURE

ΒΑΝΑ Θ-Θ ΜΕ ΓΛΩΣΣΑ
BRASS GATE VALVE



ΔΙΑΣΤΑΣΗ Dimension	ΚΩΔΙΚΟΣ Item №	Barcode		ΤΙΜΗ
1/2"	31	3800154007934	10/100	6,39
3/4"	32	3800154007941	10/100	7,81
1"	33	3800154007958	5/50	10,93
1 1/4"	34	3800154016653	5/50	16,61
1 1/2"	35	3800154023224	4/40	22,48
2"	36	3800154017032	2/20	33,41

ΠΛΑΓΙΟ ΦΙΛΤΡΟ ΚΑΘΑΡΙΣΜΟΥ ΔΙΚΤΥΟΥ ΝΕΡΟΥ (ΥΨΙΛΟΝ)
BRASS STRAINER Y TYPE



ΔΙΑΣΤΑΣΗ Dimension	ΚΩΔΙΚΟΣ Item №	Barcode		ΤΙΜΗ
1/2"	71	3800154008603	6/192	4,09
3/4"	72	3800154008610	20/120	6,84
1"	73	3800154008627	12/72	9,04
1 1/4"	74	3800154008634	6/36	20,25
1 1/2"	75	3800154008641	5/30	23,40
2"	76	3800154008658	2/12	35,92

ΜΕΙΩΤΗΣ ΠΙΕΣΗΣ
BRASS PRESSURE REDUCER VALVE



ΔΙΑΣΤΑΣΗ Dimension	ΚΩΔΙΚΟΣ Item №	Barcode		ΤΙΜΗ
1/2"	2447	3800154008832	1/50	17,32
3/4"	2451	3800154008849	1/50	18,24



THS[®]
THERMOSTYLE





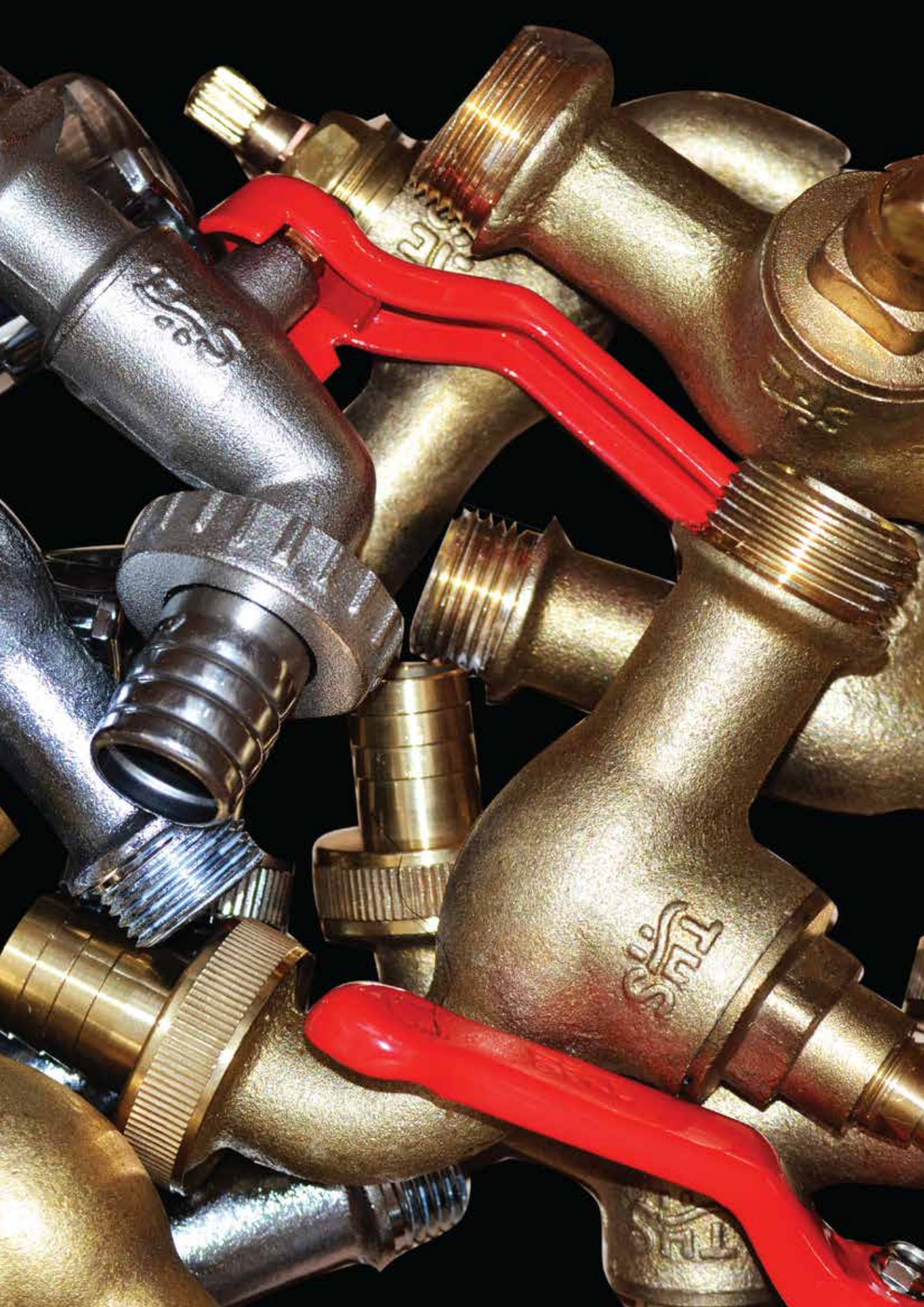

ΟΡΕΙΧΑΔΙΚΙΝΕΣ ΚΑΝΟΥΛΕΣ BRASS BIBCOCKS

ΚΑΝΟΥΛΑ ΒΑΡΕΩΣ ΤΥΠΟΥ ΑΝΤΙΠΑΓΕΤΙΚΗ ΜΕ ΛΟΥΚΕΤΟ BRASS BALL BIBCOCK ANTI-FROST WITH LOCK



Размер Dimension	Αрт. № Item №	Баркод Barcode		ΤΙΜΗ
1/2" * 3/4"	9379	3800154037498	1/160	14,96

ΚΑΝΟΥΛΑ ΒΑΡΕΩΣ ΤΥΠΟΥ ΑΝΤΙΠΑΓΕΤΙΚΗ ΜΕ ΛΟΥΚΕΤΟ BRASS BALL BIBCOCK ANTI-FROST WITH LOCK



Размер Dimension	Αрт. № Item №	Баркод Barcode		ΤΙΜΗ
1/2"	84262	3800154035111	1/84	10,35

ΚΑΝΟΥΛΑ ΒΑΡΕΩΣ ΤΥΠΟΥ BRASS BALL BIBCOCK WITH CONNECTOR HEAVY TYPE



ΔΙΑΣΤΑΣΗ Dimension	ΚΩΔΙΚΟΣ Item №	Barcode		ΤΙΜΗ
1/2"	6743	3800154027680	9/108	6,81

ΚΑΝΟΥΛΑ ΕΛΑΦΡΙΟΥ ΤΥΠΟΥ BRASS BALL BIBCOCK



ΔΙΑΣΤΑΣΗ Dimension	ΚΩΔΙΚΟΣ Item №	Barcode		ΤΙΜΗ
1/2"	190	3800154008702	12/144	5,58
3/4"	165	3800154008719	10/120	7,68
1"	1651	3800154018954	4/48	8,25

ΚΑΝΟΥΛΑ ΚΟΝΤΗ BRASS BIBCOCK MINI



ΔΙΑΣΤΑΣΗ Dimension	ΚΩΔΙΚΟΣ Item №	Barcode		ΤΙΜΗ
1/2" ΧΡΩΜΕ/CHROME PLATED	5834	3800154022012	10/100	5,84
3/4" ΧΡΩΜΕ/CHROME PLATED	5835	3800154022050	10/100	5,84
1/2" ΧΡΥΣΟ/GOLD COLOR	5838	3800154022005	10/100	5,66
3/4" ΧΡΥΣΟ/GOLD COLOR	5839	3800154022043	10/100	5,66

ΚΑΝΟΥΛΑ ΚΟΝΤΗ ΜΕ ΡΑΚΟΡ ΛΑΣΤΙΧΟΣΩΛΗΝΑ BRASS BIBCOCK MINI WITH UNION FOR GARDEN HOSE



ΔΙΑΣΤΑΣΗ Dimension	ΚΩΔΙΚΟΣ Item №	Barcode		ΤΙΜΗ
1/2" ΧΡΩΜΕ/CHROME PLATED	5836	3800154022036	10/100	5,90
3/4" ΧΡΩΜΕ/CHROME PLATED	5837	3800154022074	8/80	7,68
1/2" ΧΡΥΣΟ/GOLD COLOR	5840	3800154022029	10/100	6,26
3/4" ΧΡΥΣΟ/GOLD COLOR	5841	3800154022067	8/80	7,47

THS
THERMOSTYLE



ΚΑΝΟΥΛΕΣ ΟΡΕΙΧΑΛΚΙΝΕΣ BRASS BIBCOCKS

ΚΑΝΟΥΛΑ ΜΑΚΡΥΛΑΙΜΗ BRASS STOP BIBCOCK



ΔΙΑΣΤΑΣΗ Dimension	ΚΩΔΙΚΟΣ Item №	Barcode		ΤΙΜΗ
1/2" ΚΙΤΡΙΝΟ / YELLOW	463	3800154008740		7,99
3/4" ΚΙΤΡΙΝΟ / YELLOW	4102	3800154008764		13,15
1/2" ΝΙΚΕΛ / NICKEL PLATED	464	3800154016813		7,28

ΚΑΝΟΥΛΑ ΜΑΚΡΥΛΑΙΜΗ ΜΕ ΡΑΚΟΡ ΛΑΣΤΙΧΟΣΩΛΗΝΑ YELLOW BRASS STOP BIBCOCK WITH UNION FOR GARDEN HOSE



ΔΙΑΣΤΑΣΗ Dimension	ΚΩΔΙΚΟΣ Item №	Barcode		ΤΙΜΗ
1/2" ΚΙΤΡΙΝΟ / YELLOW	446	3800154008757		9,83
3/4" ΚΙΤΡΙΝΟ / YELLOW	4101	3800154008771		15,96

ΚΑΝΟΥΛΑ ΓΡΗΓΟΡΗΣ ΣΥΝΔΕΣΗΣ ΜΕ ΠΡΟΣΑΡΜΟΓΕΑ YELLOW BRASS STOP BIBCOCK WITH QUICK CONNECTOR



ΔΙΑΣΤΑΣΗ Dimension	ΚΩΔΙΚΟΣ Item №	Barcode		ΤΙΜΗ
1/2"	7495	3800154029363		9,80
3/4"	7496	3800154029387		16,27
1/2" ΝΙΚΕΛ / NICKEL PLATED	1405	3800154016820		10,64
3/4" ΝΙΚΕΛ / NICKEL PLATED	9143	3800154016820		13,52

ΚΑΝΟΥΛΑ ΜΕ ΡΑΚΟΡ ΝΙΚΕΛ BRASS STOP BIBCOCK WITH UNION FOR GARDEN HOSE NICKEL PLATED



ΔΙΑΣΤΑΣΗ Dimension	ΚΩΔΙΚΟΣ Item №	Barcode		ΤΙΜΗ
1/2" VITA	5794	3800154021725		12,63
1/2" DALIA	5795	3800154021732		10,64
1/2" ROSITSA	5796	3800154021749		10,85
1/2" ΙΣΚΑΡ ΛΕΥΚΟ / WHITE	5797	3800154021756		10,45
1/2" ΙΣΚΑΡ ΧΡΟΜΕ / CHROME	5798	3800154021763		11,34

ΚΑΝΟΥΛΑ ΜΕ ΛΕΥΚΗ ΛΑΒΗ YELLOW BRASS STOP BIBCOCK WITH WHITE HANDLE



ΔΙΑΣΤΑΣΗ Dimension	ΚΩΔΙΚΟΣ Item №	Barcode		ΤΙΜΗ
1/2" ΚΙΤΡΙΝΟ/YELLOW	4631	3800154021565		6,50
1/2" ΜΕ ΓΡΗΓΟΡΗ ΣΥΝΔΕΣΗ WITH QUICK CONNECTOR	4461	3800154021572		9,20

ΜΗΧΑΝΙΣΜΟΣ ΓΙΑ ΚΑΝΟΥΛΑ CARTAGE FOR STOP BIBCOCK



ΔΙΑΣΤΑΣΗ Dimension	ΚΩΔΙΚΟΣ Item №	Barcode		ΤΙΜΗ
1/2" ΚΙΤΡΙΝΟ/YELLOW	1501	3800154008818		3,04
3/4" ΚΙΤΡΙΝΟ/YELLOW	1502	3800154008825		4,74
1/2" ΝΙΚΕΛ / NICKEL PLATED	1505	3800154021541		3,14
3/4" ΝΙΚΕΛ / NICKEL PLATED	1506	3800154021558		4,95

ΚΑΝΟΥΛΕΣ ΟΡΕΙΧΑΛΚΙΝΕΣ BRASS BIBCOCKS

ΚΑΝΟΥΛΑ 9cm ΕΠΙΧΡΩΜΙΩΜΕΝΗ BIBCOCK 9 cm BRASS CHROME PLATED



ΔΙΑΣΤΑΣΗ Dimension	ΚΩΔΙΚΟΣ Item N°	Barcode		ΤΙΜΗ
1/2" VITA	8933	3800154008788	1/60	11,76
1/2" DALIA	434	3800154016837	1/60	11,76
1/2" ΙΣΚΑΡ ΛΕΥΚΟ/WHITE	1598009	3800154021848	1/60	8,93
1/2" ΙΣΚΑΡ ΧΡΟΜΕ/CHROME	8934	3800154021800	1/60	10,03
1/2" ROSITSA	1504	3800154021824	1/60	9,62
1/2" AMB	8932	3800154022104	1/60	8,41
1/2" RETRO	7556	3800154030192	1/60	10,61

ΚΑΝΟΥΛΑ 15cm ΕΠΙΧΡΩΜΙΩΜΕΝΗ BIBCOCK 15 cm BRASS CHROME PLATED



ΔΙΑΣΤΑΣΗ Dimension	ΚΩΔΙΚΟΣ Item N°	Barcode		ΤΙΜΗ
1/2" VITA	462	3800154008795	1/50	14,80
1/2" DALIA	436	3800154016844	1/50	12,76
1/2" ΙΣΚΑΡ ΛΕΥΚΟ/WHITE	1598015	3800154021855	1/50	12,39
1/2" ΙΣΚΑΡ ΧΡΟΜΕ/CHROME	8960	3800154021817	1/50	13,28
1/2" ROSITSA	1503	3800154021831	1/50	12,86
1/2" AMB	4621	3800154022098	1/50	11,66
1/2" RETRO	7557	3800154030185	1/50	15,17

ΔΙΑΚΟΠΤΗΣ ΔΙΠΛΟΣ BIBCOCK DOUBLE EXIT BRASS CHROME PLATED



ΔΙΑΣΤΑΣΗ Dimension	ΚΩΔΙΚΟΣ Item N°	Barcode		ΤΙΜΗ
1/2" * 3/4"	1500	3800154008801	1/80	10,93

ΣΥΝΤΡΙΒΑΝΙ ΤΟΙΧΟΥ BRASS FOUNTAIN BUBBLER



ΔΙΑΣΤΑΣΗ Dimension	ΚΩΔΙΚΟΣ Item N°	Barcode		ΤΙΜΗ
1/2"	862	3800154029424	1/20	17,13



ΚΑΝΟΥΛΕΣ ΔΙΑΚΟΣΜΗΤΙΚΕΣ ΟΡΕΙΧΑΛΚΙΝΕΣ BRASS BIBCOCKS

ΚΑΝΟΥΛΑ ΔΙΑΚΟΣΜΗΤΙΚΗ ΛΙΟΝΤΑΡΙ DECORATIVE BRASS BALL BIBCOCK / LION



ΔΙΑΣΤΑΣΗ Dimension	ΚΩΔΙΚΟΣ Item №	Barcode		ΤΙΜΗ
1/2"	439	3800154008733	1/30	30,39

ΚΑΝΟΥΛΑ ΣΦΑΙΡΙΚΗ ΔΙΑΚΟΣΜΗΤΙΚΗ ΛΙΟΝΤΑΡΙ DECORATIVE BRASS STOP BIBCOCK / LION



ΔΙΑΣΤΑΣΗ Dimension	ΚΩΔΙΚΟΣ Item №	Barcode		ΤΙΜΗ
1/2"	438	3800154008726	1/30	29,50

ΚΑΝΟΥΛΑ ΔΙΑΚΟΣΜΗΤΙΚΗ ΚΟΚΟΡΑΣ DECORATIVE BRASS STOP BIBCOCK ROOSTER



ΔΙΑΣΤΑΣΗ Dimension	ΚΩΔΙΚΟΣ Item №	Barcode		ΤΙΜΗ
1/2"	4392	3800154025655	1/30	34,06

ΚΑΝΟΥΛΑ ΔΙΑΚΟΣΜΗΤΙΚΗ ΠΟΥΛΙ DECORATIVE BRASS STOP BIBCOCK



ΔΙΑΣΤΑΣΗ Dimension	ΚΩΔΙΚΟΣ Item №	Barcode		ΤΙΜΗ
1/2"	4393	3800154025686	1/30	29,55

ΚΑΝΟΥΛΑ ΔΙΑΚΟΣΜΗΤΙΚΗ ΨΑΡΙ DECORATIVE BRASS STOP BIBCOCK FISH



ΔΙΑΣΤΑΣΗ Dimension	ΚΩΔΙΚΟΣ Item №	Barcode		ΤΙΜΗ
1/2"	4394	3800154025679	1/30	42,44

ΚΑΝΟΥΛΑ ΔΙΑΚΟΣΜΗΤΙΚΗ ΒΑΤΡΑΧΟΣ DECORATIVE BRASS STOP BIBCOCK FROG



ΔΙΑΣΤΑΣΗ Dimension	ΚΩΔΙΚΟΣ Item №	Barcode		ΤΙΜΗ
1/2"	4395	3800154025662	1/30	34,24

ΚΑΝΟΥΛΑ ΔΙΑΚΟΣΜΗΤΙΚΗ ΠΑΠΙΑ DECORATIVE BRASS STOP BIBCOCK DUCK



ΔΙΑΣΤΑΣΗ Dimension	ΚΩΔΙΚΟΣ Item №	Barcode		ΤΙΜΗ
1/2"	4396	3800154025693	1/30	36,68

ΛΑΒΕΣ ΓΙΑ ΚΑΝΟΥΛΑ ΔΙΑΚΟΣΜΗΤΙΚΗ ΛΙΟΝΤΑΡΙ CARTAGES FOR DECORATIVE BRASS BALL BIBCOCKS / LION



Размер Dimension	Αрт. № Item №	Баркод Barcode		ΤΙΜΗ
1/2"	43801	3800154040351	1/100	6,47
1/2"	43901	3800154040368	1/100	7,23

TMS
THERMOSTYLE



ΚΑΝΟΥΛΑ ΜΕ ΤΑΧΥΣΥΝΔΕΣΜΟ

CAST IRON BIBCOCK WITH QUICK COUPLER HOSE CONNECTION TIP



Размер Dimension	Αрт. № Item №	Баркод Barcode		ΤΙΜΗ
1/2"	99994	3800154052361		6,55
3/4"	99995	3800154052392		9,30

ΚΑΝΟΥΛΑ ΜΕ ΤΑΧΥΣΥΝΔΕΣΜΟ

IRON BIBCOCK WITH ALUMINIUM HOSE CONNECTION TIP



Размер Dimension	Αрт. № Item №	Баркод Barcode		ΤΙΜΗ
1/2"	99999	3800154052453		7,21
3/4"	100000	3800154052422		10,19

ΡΑΚΟΡ ΚΑΝΟΥΛΑΣ ΓΡΗΓΟΡΗΣ ΣΥΝΔΕΣΗΣ

BRASS QUICK CONNECTOR FOR GARDEN HOSE



ΔΙΑΣΤΑΣΗ Dimension	ΚΩΔΙΚΟΣ Item №	Barcode		ΤΙΜΗ
1/2"	7407	3800154029370		1,28
3/4"	7497	3800154029394		2,07

ΡΑΚΟΡ ΛΑΣΤΙΧΟΣΩΛΗΝΑ ΑΡΣΕΝΙΚΟ

BRASS UNION FOR GARDEN HOSE



ΔΙΑΣΤΑΣΗ Dimension	ΚΩΔΙΚΟΣ Item №	Barcode		ΤΙΜΗ
1/2" M * 12 mm	175	3800154008856		1,26
3/4" M * 20 mm	176	3800154008863		1,60
1" M * 25 mm	178	3800154008870		2,46

ΡΑΚΟΡ ΥΔΡΟΜΕΤΡΟΥ
BRASS UNION FOR WATER METER



ΔΙΑΣΤΑΣΗ Dimension	ΚΩΔΙΚΟΣ Item №	Barcode		ΤΙΜΗ
1/2" * 3/4"	1619	3800154004537		3,01
3/4" * 1"	169	3800154004544		4,06
1" * 1 1/4"	1601	3800154025617		7,00

ΟΡΕΙΧΑΛΚΙΝΑ ΕΠΙΧΡΩΜΙΩΜΕΝΑ ΕΞΑΡΤΗΜΑΤΑ

BRASS FITTINGS CHROME PLATED

ΠΡΟΣΘΗΚΗ Β.Τ. ΧΡΩΜΕ ΣΕ ΣΥΣΚΕΥΑΣΙΑ

BRASS CHROME PLATED EXTENSIONS TAG/ SINGLE BLISTER HEAVY TYPE



ΔΙΑΣΤΑΣΗ Dimension	ΚΩΔΙΚΟΣ Item №	Barcode		ΤΙΜΗ
3/8" * 10 mm	18287	3800154031663	10/400	0,89
3/8" * 15 mm	18292	3800154031670	10/300	1,13
3/8" * 20 mm	18293	3800154031687	10/280	1,36
3/8" * 25 mm	18294	3800154031694	10/240	1,62
3/8" * 30 mm	18295	3800154031700	10/240	1,91
3/8" * 40 mm	18296	3800154031717	10/180	2,67
3/8" * 50 mm	18297	3800154031724	10/140	2,83
3/8" * 60 mm	18298	3800154031731	10/120	3,30

ΔΙΑΣΤΑΣΗ Dimension	ΚΩΔΙΚΟΣ Item №	Barcode		ΤΙΜΗ
1/2" * 10 mm	187092	3800154025006	1/250	1,99
1/2" * 15 mm	187093	3800154025013	1/250	2,44
1/2" * 20 mm	187094	3800154025020	1/250	2,86
1/2" * 25 mm	187095	3800154025037	1/250	3,30
1/2" * 30 mm	187096	3800154025044	1/250	3,77
1/2" * 40 mm	187097	3800154025051	1/140	4,90
1/2" * 50 mm	187098	3800154025068	1/140	5,90
1/2" * 60 mm	187099	3800154025075	1/140	6,94
1/2" * 70 mm	187100	3800154025082	1/120	8,67
1/2" * 80 mm	187101	3800154025099	1/120	9,69
1/2" * 90 mm	187102	3800154025105	1/120	11,37
1/2" * 100 mm	187103	3800154025112	1/120	12,58

ΠΡΟΣΘΗΚΗ ΧΡΩΜΕ

BRASS CHROME PLATED EXTENSION



ΠΡΟΣΘΗΚΗ ΧΡΩΜΕ

BRASS CHROME PLATED EXTENSION



ΔΙΑΣΤΑΣΗ Dimension	ΚΩΔΙΚΟΣ Item №	Barcode		ΤΙΜΗ
1/2" * 10 mm	18092	3800154002809	10/400	1,15
1/2" * 15 mm	18093	3800154002816	10/300	1,52
1/2" * 20 mm	18094	3800154002823	10/280	1,78
1/2" * 25 mm	18095	3800154002830	10/240	2,02
1/2" * 30 mm	18096	3800154002847	10/240	2,23
1/2" * 40 mm	18097	3800154002854	10/180	2,75
1/2" * 50 mm	18098	3800154002861	10/140	3,30
1/2" * 60 mm	18099	3800154002878	10/120	3,88
1/2" * 70 mm	180100	3800154002885	10/110	4,66
1/2" * 80 mm	180101	3800154002892	10/110	5,27
1/2" * 90 mm	180102	3800154002908	10/100	5,76
1/2" * 100 mm	180103	3800154002915	10/100	6,00

ΔΙΑΣΤΑΣΗ Dimension	ΚΩΔΙΚΟΣ Item №	Barcode		ΤΙΜΗ
3/4" * 10 mm	18104	3800154002922	10/200	1,31
3/4" * 15 mm	18105	3800154002939	10/350	1,39
3/4" * 20 mm	18106	3800154002946	10/140	2,07
3/4" * 25 mm	18107	3800154002953	10/200	2,17
3/4" * 30 mm	18108	3800154002960	10/350	2,75
3/4" * 40 mm	18109	3800154002977	10/180	3,33
3/4" * 50 mm	18110	3800154002984	10/150	3,96
3/4" * 60 mm	18111	3800154002991	5/100	4,11
3/4" * 70 mm	18112	3800154003004	10/100	4,24
3/4" * 80 mm	18113	3800154003011	10/80	4,93
3/4" * 90 mm	18114	3800154003028	10/80	5,48
3/4" * 100 mm	18115	3800154003035	10/80	5,95



ΟΡΕΙΧΑΛΚΙΝΑ ΕΞΑΡΤΗΜΑΤΑ ΧΡΩΜΕ

BRASS FITTINGS CHROME PLATED

ΜΑΣΤΟΣ ΕΞΑΓΩΝΟΣ ΧΡΩΜΕ

NIPPEL BRASS CHROME PLATED



ΔΙΑΣΤΑΣΗ Dimension	ΚΩΔΙΚΟΣ Item N°	Barcode		ΤΙΜΗ
1/4"	18691	3800154021350	10/900	0,68
3/8"	1867	3800154003042	10/500	0,92
1/2"	1868	3800154003059	10/400	1,15
3/4"	1869	3800154003066	10/200	1,76
1"	1870	3800154003073	10/120	3,09
1/2" TM	181868	3800154033193	10/400	1,28

ΜΑΣΤΟΣ ΣΥΣΤΟΛΙΚΟΣ ΧΡΩΜΕ

NIPPEL REDUCING BRASS CHROME PLATED



ΔΙΑΣΤΑΣΗ Dimension	ΚΩΔΙΚΟΣ Item N°	Barcode		ΤΙΜΗ
1/2" * 1/4"	186107	3800154023149	10/500	1,10
1/2" * 3/8"	1871	3800154003080	10/400	1,05
3/4" * 1/2"	1872	3800154003097	10/250	1,65
1" * 1/2"	1850	3800154003103	15/210	2,44
1" * 3/4"	1816	3800154003110	10/150	2,80

ΜΟΥΦΑ ΧΡΩΜΕ

SOCKET BRASS CHROME PLATED



ΔΙΑΣΤΑΣΗ Dimension	ΚΩΔΙΚΟΣ Item N°	Barcode		ΤΙΜΗ
3/8"	1843	3800154003127	10/300	1,31
1/2"	1873	3800154003134	10/250	1,49
3/4"	1874	3800154003141	10/150	2,49
1"	1875	3800154003158	10/100	3,88
1/2" TM	181873	3800154033216	10/400	1,55

ΜΟΥΦΟΜΑΣΤΟΣ ΣΥΣΤΟΛΙΚΟΣ Θ-Θ ΧΡΩΜΕ

SOCKET REDUCING BRASS CHROME PLATED



ΔΙΑΣΤΑΣΗ Dimension	ΚΩΔΙΚΟΣ Item N°	Barcode		ΤΙΜΗ
1/2" * 3/8"	1841	3800154003165	10/300	1,47
3/4" * 1/2"	1842	3800154003172	10/200	2,31
1" * 1/2"	18205	3800154003189	10/210	3,62
1" * 3/4"	18206	3800154003196	10/180	3,62

ΜΟΥΦΟΜΑΣΤΟΣ ΕΞΑΓΩΝΟΣ Θ-Α ΧΡΩΜΕ

SOCKET NIPPEL BRASS CHROME PLATED FM



ΔΙΑΣΤΑΣΗ Dimension	ΚΩΔΙΚΟΣ Item N°	Barcode		ΤΙΜΗ
1/2" * 1/2"	186105	3800154023156	10/250	1,83
3/4" * 3/4"	186106	3800154023163	10/200	2,75

ΜΟΥΦΟΜΑΣΤΟΣ ΕΞΑΓΩΝΟΣ ΣΥΣΤΟΛΙΚΟΣ Θ-Α ΧΡΩΜΕ

SOCKET REDUCER NIPPEL BRASS CHROME PLATED FM



ΔΙΑΣΤΑΣΗ Dimension	ΚΩΔΙΚΟΣ Item N°	Barcode		ΤΙΜΗ
1/2" * 3/8"	1876	3800154003202	10/450	1,05
3/4" * 1/2"	1877	3800154003219	10/250	1,68
1" * 1/2"	18208	3800154003226	10/140	3,51
1" * 3/4"	18207	3800154003233	10/140	3,46





ΟΡΕΙΧΑΛΚΙΝΑ ΕΞΑΡΤΗΜΑΤΑ ΧΡΩΜΕ

BRASS FITTINGS CHROME PLATED

ΣΥΣΤΟΛΗ ΑΜΕΡΙΚΗΣ ΧΡΩΜΕ

BUSHING BRASS CHROME PLATED MF





ΔΙΑΣΤΑΣΗ Dimension	ΚΩΔΙΚΟΣ Item N°	Barcode		ΤΙΜΗ
1/2" * 1/4"	18300	3800154003240		0,89
1/2" * 3/8"	1878	3800154003257		0,68
3/4" * 1/2"	1879	3800154003264		1,31
1" * 1/2"	18200	3800154003271		2,86
1" * 3/4"	189	3800154003288		2,10
1 1/4" * 3/4"	18223	3800154023170		6,34
1 1/4" * 1"	18224	3800154021343		2,65

ΤΑΠΑ ΣΩΜΑΤΟΣ ΧΡΩΜΕ

END BRASS MALE WITH RUBBER







ΔΙΑΣΤΑΣΗ Dimension	ΚΩΔΙΚΟΣ Item N°	Barcode		ΤΙΜΗ
1/2"	24161	3800154003295		0,92

ΤΑΠΑ ΑΡΣΕΝΙΚΗ ΧΡΩΜΕ

END CAP BRASS CHROME PLATED MALE







ΔΙΑΣΤΑΣΗ Dimension	ΚΩΔΙΚΟΣ Item N°	Barcode		ΤΙΜΗ
3/8"	18305	3800154003301		0,81
1/2"	1864	3800154003318		0,84
3/4"	1865	3800154003325		1,44
1"	18204	3800154003332		1,86

ΤΑΠΑ ΘΗΛΥΚΗ ΧΡΩΜΕ

END CAP BRASS CHROME PLATED FEMALE









ΔΙΑΣΤΑΣΗ Dimension	ΚΩΔΙΚΟΣ Item N°	Barcode		ΤΙΜΗ
3/8"	18306	3800154003356		1,10
1/2"	1866	3800154003363		1,07
3/4"	18202	3800154003370		1,57
1"	18203	3800154003387		2,75

ΓΩΝΙΑ Θ-Θ ΧΡΩΜΕ

ELBOW BRASS CHROME PLATED FF







ΔΙΑΣΤΑΣΗ Dimension	ΚΩΔΙΚΟΣ Item N°	Barcode		ΤΙΜΗ
3/8"	1854	3800154003400		1,70
1/2"	1855	3800154003417		2,07
3/4"	1856	3800154003424		3,55
1"	1881	3800154003431		8,75
1/2" TM	181855	3800154033209		2,88

ΓΩΝΙΑ Θ-Θ ΣΥΣΤΟΛΙΚΗ ΧΡΩΜΕ

ELBOW REDUCER BRASS CHROME PLATED FF



ΔΙΑΣΤΑΣΗ Dimension	ΚΩΔΙΚΟΣ Item N°	Barcode		ΤΙΜΗ
3/4" * 1/2"	18225	3800154023187		2,78
1" * 1/2"	18209	3800154025709		4,95
1" * 3/4"	18210	3800154025716		5,21

THS[®]
THERMOSTYLE



ΟΡΕΙΧΑΛΚΙΝΑ ΕΞΑΡΤΗΜΑΤΑ ΧΡΩΜΕ

BRASS FITTINGS CHROME PLATED

ΓΩΝΙΑ Α-Θ ΧΡΩΜΕ

ELBOW BRASS CHROME PLATED FM



ΔΙΑΣΤΑΣΗ Dimension	ΚΩΔΙΚΟΣ Item N°	Barcode		ΤΙΜΗ
3/8"	1857	3800154003448	10/300	1,83
1/2"	1858	3800154003455	10/160	2,46
3/4"	1859	3800154003462	10/100	5,06
1"	1882	3800154003479	10/70	7,91
1/2"TM	181858	3800154033223	10/160	3,69

ΓΩΝΙΑ Α-Θ ΣΥΣΤΟΛΙΚΗ ΧΡΩΜΕ

ELBOW REDUCER BRASS CHROME PLATED FM



ΔΙΑΣΤΑΣΗ Dimension	ΚΩΔΙΚΟΣ Item N°	Barcode		ΤΙΜΗ
1/2" * 3/4"	18211	3800154024320	10/150	2,57

ΓΩΝΙΑ Α-Α ΧΡΩΜΕ

ELBOW BRASS CHROME PLATED MM



ΔΙΑΣΤΑΣΗ Dimension	ΚΩΔΙΚΟΣ Item N°	Barcode		ΤΙΜΗ
1/2"	1851	3800154003486	10/200	1,86
3/4"	18212	3800154003493	10/100	2,04

ΤΑΥ ΘΗΛΥΚΟ ΧΡΩΜΕ

TEE BRASS CHROME PLATED FFF



ΔΙΑΣΤΑΣΗ Dimension	ΚΩΔΙΚΟΣ Item N°	Barcode		ΤΙΜΗ
3/8"	1860	3800154003509	10/180	2,12
1/2"	1861	3800154003516	10/140	2,70
3/4"	1862	3800154003523	10/60	3,75
1"	1880	3800154003530	10/40	7,91
1/2"TM	181861	3800154033230	10/40	4,24

ΤΑΥ ΘΗΛΥΚΟ ΣΥΣΤΟΛΙΚΟ ΧΡΩΜΕ

TEE REDUCER BRASS CHROME PLATED FFF



ΔΙΑΣΤΑΣΗ Dimension	ΚΩΔΙΚΟΣ Item N°	Barcode		ΤΙΜΗ
3/4" * 1/2" * 3/4"	18214	3800154025723	10/120	3,64
1" * 1/2" * 1"	18215	3800154025730	10/80	6,37
1" * 3/4" * 1"	18222	3800154025747	10/70	6,73

ΤΑΥ ΑΡΣΕΝΙΚΟ ΧΡΩΜΕ

TEE BRASS CHROME PLATED MMM



ΔΙΑΣΤΑΣΗ Dimension	ΚΩΔΙΚΟΣ Item N°	Barcode		ΤΙΜΗ
1/2"	18219	3800154003547	10/150	3,38
3/4"	18220	3800154003554	10/70	5,53
1"	18221	3800154003561	10/140	9,56



ΟΡΕΙΧΑΛΚΙΝΑ ΕΞΑΡΤΗΜΑΤΑ ΧΡΩΜΕ

BRASS FITTINGS CHROME PLATED

ΤΑΥ Θ-Α-Θ
TEE BRASS CHROME PLATED FMF



ΔΙΑΣΤΑΣΗ Dimension	ΚΩΔΙΚΟΣ Item №	Barcode		ΤΙΜΗ
1/2" * 1/2" * 1/2"	18216	3800154003578	10/120	4,11
3/4" * 3/4" * 3/4"	18218	3800154025761	10/80	3,51

ΤΑΥ ΣΥΣΤΟΛΙΚΟ Θ-Α-Θ
TEE REDUCER BRASS CHROME PLATED FMF



ΔΙΑΣΤΑΣΗ Dimension	ΚΩΔΙΚΟΣ Item №	Barcode		ΤΙΜΗ
3/4" * 1/2" * 3/4"	18217	3800154025754	10/120	2,70

ΣΤΑΥΡΟΣ
CROSS BRASS CHROME PLATED



ΔΙΑΣΤΑΣΗ Dimension	ΚΩΔΙΚΟΣ Item №	Barcode		ΤΙΜΗ
1/2"	18201	3800154003394	10/90	3,25
3/4"	186108	3800154023132	10/60	5,66

ΜΟΥΦΑ ΡΑΚΟΡ ΕΠΕΚΤΑΣΗΣ
BRASS SOCKET NIPPEL EXTENSION

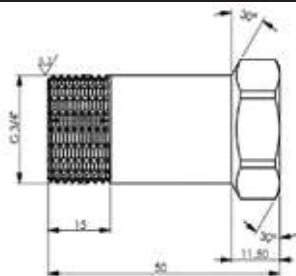

ΔΙΑΣΤΑΣΗ Dimension	ΚΩΔΙΚΟΣ Item №	Barcode		ΤΙΜΗ
3/4" x 50 mm	8488	3800154032547	1/100	3,59



TMS[®]
THERMOSTYLE







ΟΡΕΙΧΑΛΚΙΝΑ ΕΞΑΡΤΗΜΑΤΑ BRASS FITINGS

ΠΡΟΣΘΗΚΗ ΓΥΑΛΙΣΤΕΡΗ 1/2" BRASS CHROME POLISHED EXTENSION 1/2"



ΔΙΑΣΤΑΣΗ Dimension	ΚΩΔΙΚΟΣ Item №	Barcode		ΤΙΜΗ
1/2" * 10 mm	19092	3800154031786	10/400	1,28
1/2" * 15 mm	19093	3800154031793	10/300	1,62
1/2" * 20 mm	19094	3800154031809	10/280	1,91
1/2" * 25 mm	19095	3800154031816	10/240	1,81
1/2" * 30 mm	19096	3800154031823	10/240	2,33
1/2" * 40 mm	19097	3800154031830	10/180	2,86
1/2" * 50 mm	19098	3800154031847	10/140	3,41
1/2" * 60 mm	19099	3800154031854	10/120	3,96
1/2" * 70 mm	190100	3800154031861	10/110	4,30
1/2" * 80 mm	190101	3800154031878	10/110	4,66
1/2" * 90 mm	190102	3800154031885	10/100	5,29
1/2" * 100 mm	190103	3800154031892	10/100	6,08

ΠΡΟΣΘΗΚΗ 1/2" BRASS EXTENSION 1/2"



ΔΙΑΣΤΑΣΗ Dimension	ΚΩΔΙΚΟΣ Item №	Barcode		ΤΙΜΗ
1/2" * 10 mm	197092	3800154031908	1/250	1,76
1/2" * 15 mm	197093	3800154031915	1/250	2,15
1/2" * 20 mm	197094	3800154031922	1/250	2,57
1/2" * 25 mm	197095	3800154031939	1/250	2,99
1/2" * 30 mm	197096	3800154031946	1/250	3,46
1/2" * 40 mm	197097	3800154031953	1/140	4,40
1/2" * 50 mm	197098	3800154031960	1/140	5,48
1/2" * 60 mm	197099	3800154031977	1/140	6,31

ΠΡΟΣΘΗΚΗ 3/4" BRASS EXTENSION 3/4"



ΔΙΑΣΤΑΣΗ Dimension	ΚΩΔΙΚΟΣ Item №	Barcode		ΤΙΜΗ
3/4" * 10 mm	19104	3800154031984	10/200	1,81
3/4" * 15 mm	19105	3800154031991	10/350	2,20
3/4" * 20 mm	19106	3800154032004	10/140	2,57
3/4" * 25 mm	19107	3800154032011	10/200	3,01
3/4" * 30 mm	19108	3800154032028	10/350	3,41
3/4" * 40 mm	19109	3800154032035	10/180	4,19
3/4" * 50 mm	19110	3800154032042	10/150	5,19
3/4" * 60 mm	19111	3800154032059	10/100	6,08

ΠΡΟΣΘΗΚΗ 1" BRASS EXTENSION 1"



ΔΙΑΣΤΑΣΗ Dimension	ΚΩΔΙΚΟΣ Item №	Barcode		ΤΙΜΗ
1" * 10 mm	198348	3800154032066	10/200	3,01
1" * 15 mm	198349	3800154032073	10/150	3,64
1" * 20 mm	198350	3800154032080	10/130	4,30
1" * 25 mm	198351	3800154032097	10/120	4,90
1" * 30 mm	198352	3800154032103	10/100	5,37
1" * 40 mm	198353	3800154032110	10/80	6,39
1" * 50 mm	198354	3800154032127	10/70	8,10











ΟΡΕΙΧΑΛΚΙΝΑ ΕΞΑΡΤΗΜΑΤΑ

BRASS FITINGS

ΜΑΣΤΟΣ ΕΞΑΓΩΝΟΣ

NIPPEL BRASS

















ΔΙΑΣΤΑΣΗ Dimension	ΚΩΔΙΚΟΣ Item №	Barcode		ΤΙΜΗ
3/8"	1967	3800154028557		0,79
1/2"	1968	3800154022647		1,21
3/4"	1969	3800154022654		1,28
1"	1970	3800154022661		3,17
1 1/4"	19307	3800154022678		5,74
1 1/2"	19308	3800154022685		7,07
2"	19309	3800154022692		11,82

ΜΑΣΤΟΣ ΕΞΑΓΩΝΟΣ ΣΥΣΤΟΛΙΚΟΣ

NIPPEL REDUCER BRASS



ΔΙΑΣΤΑΣΗ Dimension	ΚΩΔΙΚΟΣ Item №	Barcode		ΤΙΜΗ
1/2" * 3/8"	1971	3800154022708		1,02
3/4" * 1/2"	1972	3800154022715		1,91
1" * 1/2"	1950	3800154022722		2,65
1" * 3/4"	1916	3800154022739		3,17
1 1/4" * 1/2"	19632	3800154022760		4,72
1 1/4" * 3/4"	19631	3800154022753		4,93
1 1/4" * 1"	19630	3800154022746		4,93
1 1/2" * 3/4"	19635	3800154022791		5,82
1 1/2" * 1"	19634	3800154022784		6,03
1 1/2" * 1 1/4"	19633	3800154022777		6,71
2" * 1"	19638	3800154022821		11,03
2" * 1 1/4"	19637	3800154022814		11,55
2" * 1 1/2"	19636	3800154022807		11,48

ΜΟΥΦΑ

SOCKET BRASS



ΔΙΑΣΤΑΣΗ Dimension	ΚΩΔΙΚΟΣ Item №	Barcode		ΤΙΜΗ
3/8"	1943	3800154028618		1,39
1/2"	1973	3800154022470		1,68
3/4"	1974	3800154022487		2,75
1"	1975	3800154022494		3,98
1 1/4"	19301	3800154022500		6,94
1 1/2"	196135	3800154022517		8,31
2"	196136	3800154022524		14,36

ΜΟΥΦΑ ΣΥΣΤΟΛΙΚΗ

SOCKET REDUCER BRASS







ΔΙΑΣΤΑΣΗ Dimension	ΚΩΔΙΚΟΣ Item №	Barcode		ΤΙΜΗ
3/4" * 1/2"	1942	3800154023231		2,17
1 1/4" * 1"	199216	2000001992166		6,94

ΜΟΥΦΟΜΑΣΤΟΣ ΕΞΑΓΩΝΟΣ ΣΥΣΤΟΛΙΚΟΣ

SOCKET NIPPEL BRASS FM



ΔΙΑΣΤΑΣΗ Dimension	ΚΩΔΙΚΟΣ Item №	Barcode		ΤΙΜΗ
1/2" * 3/8"	1976	3800154028571		1,10
3/4" * 1/2"	1977	3800154022531		1,97
1" * 3/4"	19207	3800154022548		3,88
1 1/4" * 1"	196182	3800154023248		5,45

ΤΑΥ ΑΡΣΕΝΙΚΟ

TEE BRASS MMM



ΔΙΑΣΤΑΣΗ Dimension	ΚΩΔΙΚΟΣ Item №	Barcode		ΤΙΜΗ
1/2"	19219	3800154040412		3,75
3/4"	19220	3800154040429		5,69















THS
THERMOSTYLE



ΟΡΕΙΧΑΛΚΙΝΑ ΕΞΑΡΤΗΜΑΤΑ BRASS FITINGS



ΣΥΣΤΟΛΗ ΑΜΕΡΙΚΗΣ BUSHING BRASS MF



ΔΙΑΣΤΑΣΗ Dimension	ΚΩΔΙΚΟΣ Item №	Barcode		ΤΙΜΗ
1/2" * 1/4"	19300	3800154028564		1,02
1/2" * 3/8"	1978	3800154022838		0,79
3/4" * 1/2"	1979	3800154022845		1,18
1" * 1/2"	19200	3800154022852		3,48
1" * 3/4"	199	3800154022869		2,44
1 1/4" * 3/4"	19223	3800154022883		6,24
1 1/4" * 1"	19224	3800154022876		4,53
1 1/2" * 1"	1988	3800154022906		5,48
1 1/2" * 1 1/4"	1987	3800154022890		3,72
2" * 3/4"	1989	3800154022913		11,24
2" * 1"	1990	3800154022920		13,96
2" * 1 1/4"	1991	3800154022937		11,45
2" * 1 1/2"	1992	3800154022944		10,19

ΤΑΠΑ ΘΗΛΥΚΗ CAP BRASS FEMALE



ΔΙΑΣΤΑΣΗ Dimension	ΚΩΔΙΚΟΣ Item №	Barcode		ΤΙΜΗ
1/2"	1966	3800154022951		0,94
3/4"	19202	3800154022968		1,47
1"	19203	3800154022975		2,44
1 1/4"	196157	3800154022982		3,12
1 1/2"	196158	3800154022999		4,51
2"	196159	3800154023002		6,71



ΤΑΠΑ ΑΡΣΕΝΙΚΗ CAP BRASS MALE



ΔΙΑΣΤΑΣΗ Dimension	ΚΩΔΙΚΟΣ Item №	Barcode		ΤΙΜΗ
1/2"	1964	3800154023019		0,97
3/4"	1965	3800154023026		1,31
1"	19204	3800154023033		2,88

ΓΩΝΙΑ Θ-Θ ELBOW BRASS FF



ΔΙΑΣΤΑΣΗ Dimension	ΚΩΔΙΚΟΣ Item №	Barcode		ΤΙΜΗ
3/8"	1954	3800154028588		1,94
1/2"	1955	3800154022555		2,70
3/4"	1956	3800154022562		4,40
1"	1981	3800154022579		8,25





ΓΩΝΙΑ Α-Θ ELBOW BRASS FM



ΔΙΑΣΤΑΣΗ Dimension	ΚΩΔΙΚΟΣ Item №	Barcode		ΤΙΜΗ
3/8"	1957	3800154028595		1,94
1/2"	1958	3800154022586		3,12
3/4"	1959	3800154022593		4,79
1"	1982	3800154022609		6,50

ΤΑΥ ΘΗΛΥΚΟ TEE BRASS FFF



ΔΙΑΣΤΑΣΗ Dimension	ΚΩΔΙΚΟΣ Item №	Barcode		ΤΙΜΗ
3/8"	1960	3800154028601		2,28
1/2"	1961	3800154022616		3,80
3/4"	1962	3800154022623		5,58
1"	1980	3800154022630		8,83

THS
THERMOSTYLE



ΟΡΕΙΧΑΛΚΙΝΑ ΕΞΑΡΤΗΜΑΤΑ BRASS FITINGS NICKEL PLATED

ΜΑΣΤΟΣ ΕΞΑΓΩΝΟΣ NIPPEL BRASS NICKEL PLATED

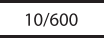
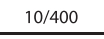
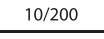
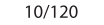

ΔΙΑΣΤΑΣΗ Dimension	ΚΩΔΙΚΟΣ Item №	Barcode		ΤΙΜΗ
3/8"	2067	3800154024566		0,79
1/2"	2068	3800154024573		1,34
3/4"	2069	3800154024580		1,83
1"	2070	3800154024597		3,98

ΜΑΣΤΟΣ ΕΞΑΓΩΝΟΣ ΣΥΣΤΟΛΙΚΟΣ NIPPEL REDUCING BRASS NICKEL PLATED

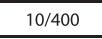
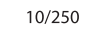

ΔΙΑΣΤΑΣΗ Dimension	ΚΩΔΙΚΟΣ Item №	Barcode		ΤΙΜΗ
1/2" * 3/8"	2071	3800154024603		1,26
3/4" * 1/2"	2072	3800154024610		2,23

ΜΟΥΦΑ SOCKET BRASS NICKEL PLATED FF

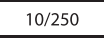
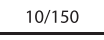
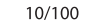

ΔΙΑΣΤΑΣΗ Dimension	ΚΩΔΙΚΟΣ Item №	Barcode		ΤΙΜΗ
1/2"	2073	3800154024627		1,65
3/4"	2074	3800154024634		2,75
1"	2075	3800154024641		4,11



ΜΟΥΦΟΜΑΣΤΟΣ SOCKET NIPPEL BRASS NICKEL PLATED FM

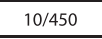
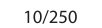

ΔΙΑΣΤΑΣΗ Dimension	ΚΩΔΙΚΟΣ Item №	Barcode		ΤΙΜΗ
1/2" * 3/8"	2076	3800154024658		1,81
3/4" * 1/2"	2077	3800154024665		2,57

ΜΟΥΦΑ ΣΥΣΤΟΛΙΚΗ SOCKET REDUCER BRASS NICKEL PLATED

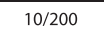

ΔΙΑΣΤΑΣΗ Dimension	ΚΩΔΙΚΟΣ Item №	Barcode		ΤΙΜΗ
1/2" * 3/8"	2041	3800154024672		1,36
3/4" * 1/2"	20421	3800154024689		2,31

ΣΥΣΤΟΛΗ ΑΜΕΡΙΚΗΣ BUSHING BRASS NICKEL PLATED MF



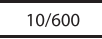
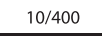
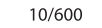



ΔΙΑΣΤΑΣΗ Dimension	ΚΩΔΙΚΟΣ Item №	Barcode		ΤΙΜΗ
1/2" * 3/8"	2078	3800154024696		0,84
3/4" * 1/2"	2079	3800154024702		1,47
1/2" * 1/4"	20300	3800154045400		1,05



ΟΡΕΙΧΑΛΚΙΝΑ ΕΞΑΡΤΗΜΑΤΑ BRASS FITINGS NICKEL PLATED





ΤΑΠΑ ΑΡΣΕΝΙΚΗ CAP BRASS NICKEL PLATED MALE



ΔΙΑΣΤΑΣΗ Dimension	ΚΩΔΙΚΟΣ Item №	Barcode		ΤΙΜΗ
1/2"	2064	3800154024719		1,00
3/4"	2065	3800154024726		1,07
1"	2024	3800154024733		2,36





ΤΑΠΑ ΘΗΛΥΚΗ CAP BRASS NICKEL PLATED FEMALE



ΔΙΑΣΤΑΣΗ Dimension	ΚΩΔΙΚΟΣ Item №	Barcode		ΤΙΜΗ
1/2"	2066	3800154024740		1,00
3/4"	2022	3800154024757		1,76
1"	2023	3800154024764		2,04





ΓΩΝΙΑ Θ-Θ ELBOW BRASS NICKEL PLATED FF



ΔΙΑΣΤΑΣΗ Dimension	ΚΩΔΙΚΟΣ Item №	Barcode		ΤΙΜΗ
3/8"	2026	3800154024771		1,60
1/2"	2055	3800154024788		2,70
3/4"	2056	3800154024795		4,32
1"	2081	3800154024801		6,39





ΓΩΝΙΑ Α-Θ ELBOW BRASS NICKEL PLATED FM



ΔΙΑΣΤΑΣΗ Dimension	ΚΩΔΙΚΟΣ Item №	Barcode		ΤΙΜΗ
3/8"	2057	3800154028625		1,57
1/2"	2090	3800154024818		3,35
3/4"	2091	3800154024825		4,93
1"	2082	3800154024832		5,34

ΤΑΦ TEE BRASS NICKEL PLATED FFF



ΔΙΑΣΤΑΣΗ Dimension	ΚΩΔΙΚΟΣ Item №	Barcode		ΤΙΜΗ
3/8"	2051	3800154024849		1,86
1/2"	2061	3800154024856		4,59
3/4"	2062	3800154024863		5,24
1"	2080	3800154024870		7,52



ΟΡΕΙΧΑΛΚΙΝΑ ΡΑΚΟΡ & ΒΑΛΒΙΔΕΣ ΑΣΦΑΛΕΙΑΣ

BRASS UNIONS AND SAFETY VALVES

ΡΑΚΟΡ ΙΣΙΟ ΚΑΛΟΡΙΦΕΡ Α-Θ ΧΡΩΜΕ
STRAIGHT UNION WITH EXTENSION BRASS NICKEL PLATED FM



ΔΙΑΣΤΑΣΗ Dimension	ΚΩΔΙΚΟΣ Item №	Barcode		ΤΙΜΗ
1/2"	115	3800154007873	10/140	3,80
3/4"	116	3800154007880	5/80	5,45
1"	117	3800154007897	5/40	10,72

ΡΑΚΟΡ ΓΩΝΙΑΚΟ ΚΑΛΟΡΙΦΕΡ Α-Θ ΧΡΩΜΕ
ANGLE UNION WITH EXTENSION BRASS NICKEL PLATED FM



ΔΙΑΣΤΑΣΗ Dimension	ΚΩΔΙΚΟΣ Item №	Barcode		ΤΙΜΗ
1/2"	1036	3800154007903	10/100	4,85
3/4"	1037	3800154007910	5/60	7,41
1"	1090	3800154007927	5/25	12,94

ΡΑΚΟΡ ΙΣΙΟ ΚΑΛΟΡΙΦΕΡ Α-Θ
STRAIGHT UNION WITH EXTENSION BRASS FM



ΔΙΑΣΤΑΣΗ Dimension	ΚΩΔΙΚΟΣ Item №	Barcode		ΤΙΜΗ
1/2"	19115	3800154028496	10/140	4,09
3/4"	19116	3800154028502	5/80	6,60
1"	19117	3800154028519	5/40	12,21

ΡΑΚΟΡ ΓΩΝΙΑΚΟ ΚΑΛΟΡΙΦΕΡ Α-Θ
ANGLE UNION WITH EXTENSION BRASS FM



ΔΙΑΣΤΑΣΗ Dimension	ΚΩΔΙΚΟΣ Item №	Barcode		ΤΙΜΗ
1/2"	191036	3800154028526	10/100	5,21
3/4"	191037	3800154028533	5/60	8,38
1"	1090	3800154007927	5/25	12,94

ΒΑΛΒΙΔΑ ΑΣΦΑΛΕΙΑΣ ΘΕΡΜΟΣΙΦΩΝΟΥ
SAFETY BRASS VALVE



ΔΙΑΣΤΑΣΗ Dimension	ΚΩΔΙΚΟΣ Item №	Barcode		ΤΙΜΗ
1/2"	166	3800154008887	1/84	3,90

ΒΑΛΒΙΔΑ ΑΣΦΑΛΕΙΑΣ ΜΕ ΜΟΧΛΟ
SAFETY BRASS VALVE WITH PLATE



ΔΙΑΣΤΑΣΗ Dimension	ΚΩΔΙΚΟΣ Item №	Barcode		ΤΙΜΗ
1/2"	167	3800154008894	1/84	4,01



Η βαλβίδα ασφαλείας είναι ρυθμισμένη στα 8bar. - Προϊόντα № 166 & № 167
The safety valve is set to 8 bars. - items № 166 and № 167

TMS[®]
THERMOSTYLE



THS[®]
THERMOSTYLE

ΕΞΟΠΛΙΣΜΟΣ
ΜΠΑΝΙΟΥ



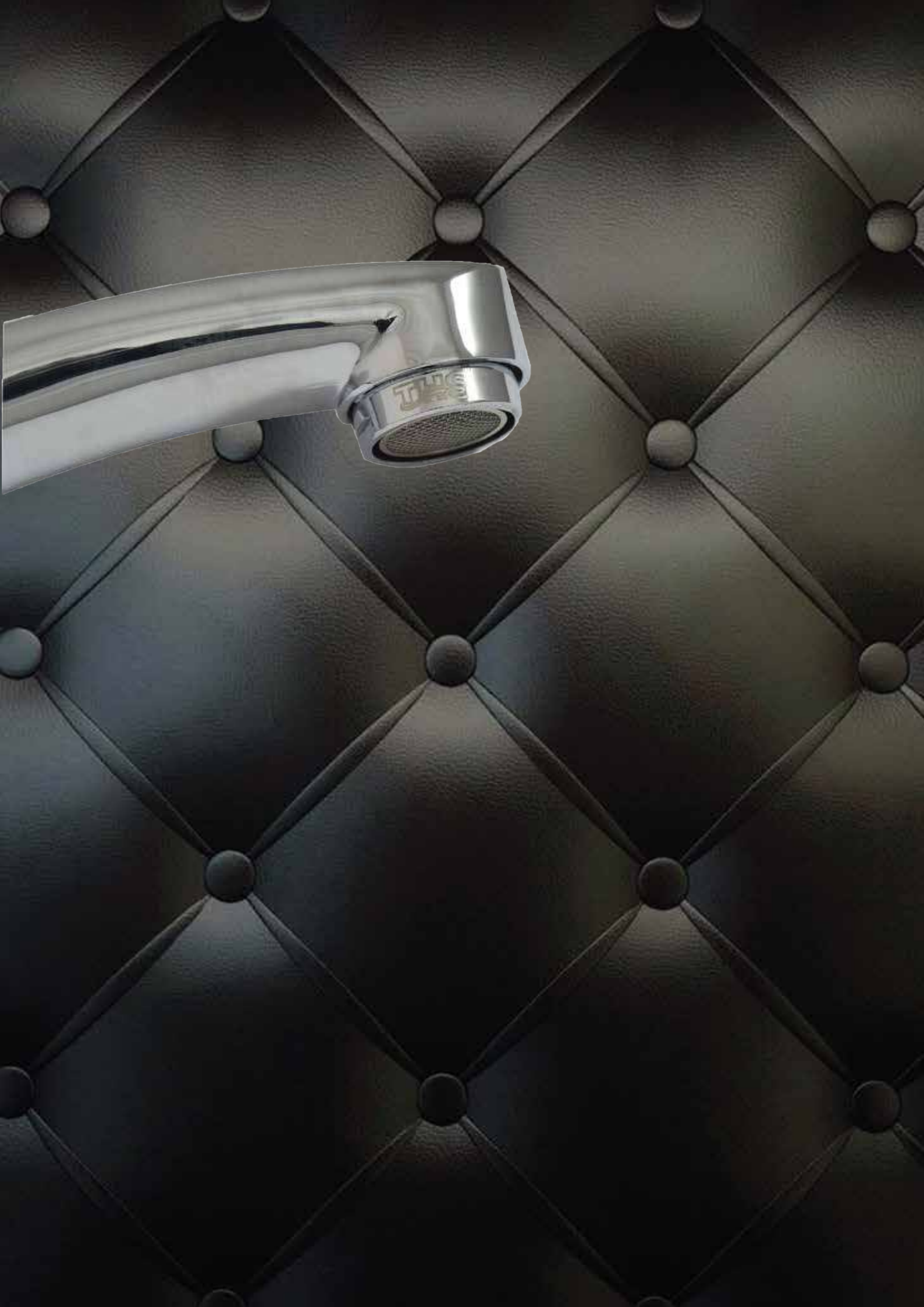

ΜΠΑΤΑΡΙΑ ΛΟΥΤΡΟΥ ΣΕΤ ROSE BATH AND SHOWER MIXER FULL SET SERIES ROSE

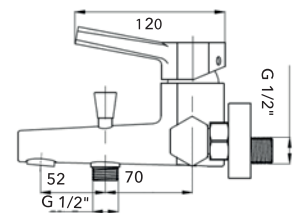
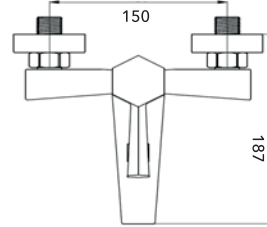
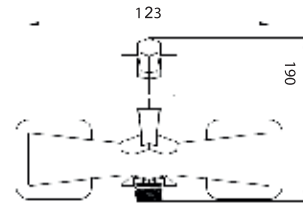



ΔΙΑΣΤΑΣΗ Dimension	ΚΩΔΙΚΟΣ Item №	Barcode		ΤΙΜΗ
Ø 35	10004	3800154040573	1/4	301,80

ΜΠΑΤΑΡΙΑ ΝΙΠΤΗΡΟΣ ΜΕ POP-UP ΣΕΙΡΑ ROSE BASIN SET WITH POP-UP SERIES ROSE

ΔΙΑΚΟΠΤΑΚΙ ΣΕΙΡΑ ROSE BRASS STOP VALVE SERIES ROSE



ΔΙΑΣΤΑΣΗ Dimension	ΚΩΔΙΚΟΣ Item №	Barcode		ΤΙΜΗ
Ø 35	10005	3800154040566	1/10	198,86

ΔΙΑΣΤΑΣΗ Dimension	ΚΩΔΙΚΟΣ Item №	Barcode		ΤΙΜΗ
1/2" * 1/2"	10006	3800154040580	1/200	19,95

The High Standard bathroom equipment for new experience



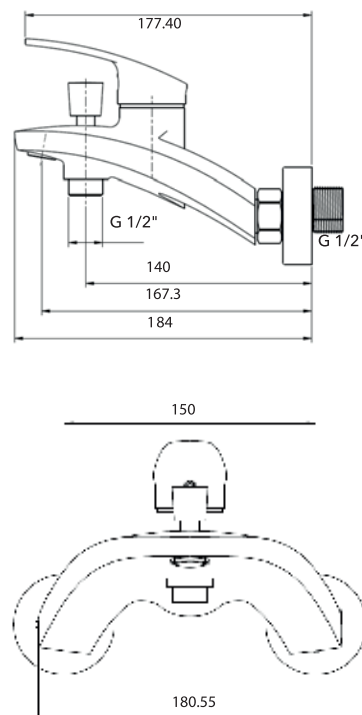

ΜΠΑΤΑΡΙΑ ΛΟΥΤΡΟΥ ΣΕΤ RAINBOW
BATH AND SHOWER MIXER FULL SET SERIES RAINBOW

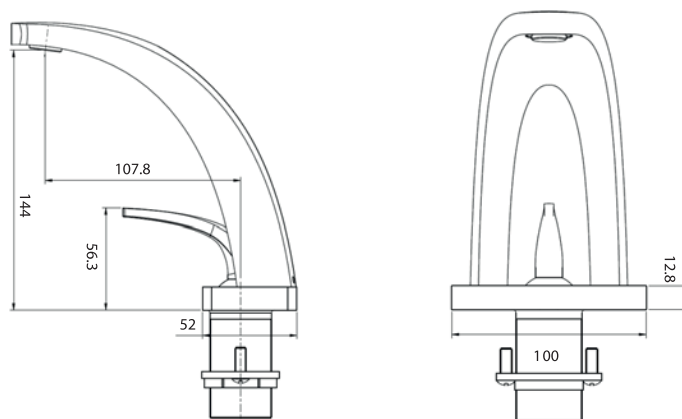

ΔΙΑΣΤΑΣΗ Dimension	ΚΩΔΙΚΟΣ Item N°	Barcode		ΤΙΜΗ
Ø 35	99611	3800154004186	1/4	402,33

ΜΠΑΤΑΡΙΑ ΝΙΠΤΗΡΟΣ ΜΕ POP-UP ΣΕΙΡΑ RAINBOW
BASIN SET WITH POP UP SERIES RAINBOW



ΔΙΑΣΤΑΣΗ Dimension	ΚΩΔΙΚΟΣ Item N°	Barcode		ΤΙΜΗ
Ø 25	99612	3800154004179	1/4	247,30

The High Standard bathroom equipment for new experience



Rainbow

ΑΞΕΣΟΥΑΡ RAINBOW ACCESSORIES RAINBOW

ΣΑΠΟΥΝΟΘΗΚΗ ΣΕΙΡΑ RAINBOW SOAP DISPENSER & HOLDER SERIES RAINBOW



ΔΙΑΣΤΑΣΗ Dimension	ΚΩΔΙΚΟΣ Item №	Barcode		ΤΙΜΗ
	99617	3800154004230	1/2	83,92

ΠΙΓΚΑΛ ΣΕΙΡΑ RAINBOW TOILET BRUSH & HOLDER FOR WC SERIES RAINBOW



ΔΙΑΣΤΑΣΗ Dimension	ΚΩΔΙΚΟΣ Item №	Barcode		ΤΙΜΗ
	99618	3800154004247	1/20	61,15

ΧΑΡΤΟΘΗΚΗ ΣΕΙΡΑ RAINBOW HOLDER FOR TOILET PAPPER SERIES RAINBOW



ΔΙΑΣΤΑΣΗ Dimension	ΚΩΔΙΚΟΣ Item №	Barcode		ΤΙΜΗ
L167mm	99615	3800154004216	1/50	65,11

ΑΓΓΙΣΤΡΟ ΣΕΙΡΑ RAINBOW ROBE HOOK SERIES RAINBOW



ΔΙΑΣΤΑΣΗ Dimension	ΚΩΔΙΚΟΣ Item №	Barcode		ΤΙΜΗ
	99616	3800154004223	1/100	37,62

ΠΕΤΣΕΤΟΚΡΕΜΑΣΤΡΑ ΣΕΙΡΑ RAINBOW RAINBOW TOWEL HANGING



ΔΙΑΣΤΑΣΗ Dimension	ΚΩΔΙΚΟΣ Item №	Barcode		ΤΙΜΗ
L632mm	99614	3800154004209	1/20	126,99

ΣΧΑΡΑΚΙ ΣΕΙΡΑ RAINBOW FLOOR DRAINER SERIES RAINBOW





ΔΙΑΣΤΑΣΗ Dimension	ΚΩΔΙΚΟΣ Item №	Barcode		ΤΙΜΗ
Ø50-100mmx100mm	99613	3800154004193	1/40	26,15

The High Standard bathroom equipment for new experience

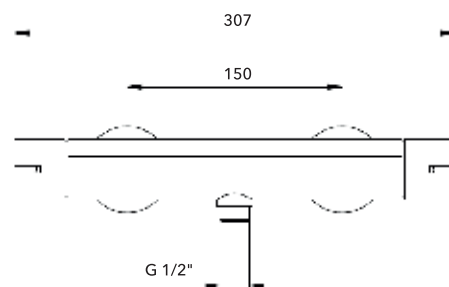
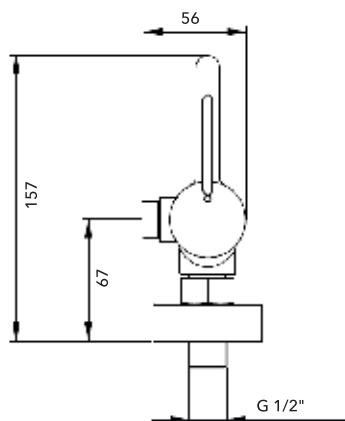

ΜΠΑΤΑΡΙΑ ΛΟΥΤΡΟΥ ΣΕΤ BLACKMATT
BATH AND SHOWER MIXER FULL SET SERIES BLACKMATT



ΔΙΑΣΤΑΣΗ Dimension	ΚΩΔΙΚΟΣ Item №	Barcode		ΤΙΜΗ
Ø 30	9969	3800154004254	1/4	460,15

ΜΠΑΤΑΡΙΑ ΝΙΠΤΗΡΟΣ BLACKMATT
BASIN SERIES BLACKMATT

ΣΧΑΡΑΚΙ ΣΕΙΡΑ BLACKMATT
FLOOR DRAINER SERIES BLACKMATT

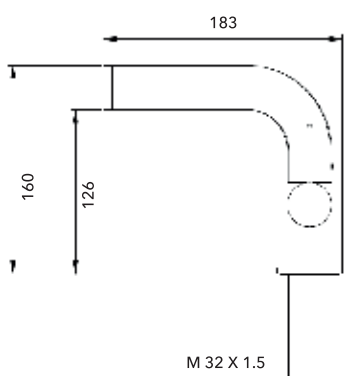

ΔΙΑΣΤΑΣΗ Dimension	ΚΩΔΙΚΟΣ Item №	Barcode		ΤΙΜΗ
Ø 25	9970	3800154004261	1/10	150,81

ΔΙΑΣΤΑΣΗ Dimension	ΚΩΔΙΚΟΣ Item №	Barcode		ΤΙΜΗ
Ø50- 100x100mm	9971	3800154004278	1/40	22,11

The High Standard bathroom equipment for new experience





8486

8487



ΣΥΣΤΗΜΑ ΜΠΙΝΤΕ ΣΗΑΤΑΦ ΜΕ ΜΗΧΑΝΙΣΜΟ ΚΛΕΙΣΙΜΑΤΟΣ THS by SEDAL
SHATTAF FULL SET WITH CARTAGE THS by SEDAL

Ολοκληρωμένο σετ, έτοιμο προς εγκατάσταση, περιλαμβάνει:

1. Μίκτης μονής λαβής εξωτερικής εγκατάστασης με μονή βάση για ντους
 -Μεταξόνιο εγκατάστασης 10cm
 -Κεραμική Βαλβίδα κλεισίματος 25mm THS by Sedal
2. Μεταλλικό stop-ντους 1/2" με μαγνητική κεφαλή για να στερεώνεται στη βάση
3. Σπιράλι 1/2" 120cm με διπλή πλέξη και ορειχάλκινα ακροφύσια. Το σπιράλι είναι ANTI-TWIST προς αποφυγή στριψίματος
4. Ορειχάλκινες ροζέτες διαμέτρου 60mm και βάθους 21mm - 2 τμχ
5. Έκκεντρα 1/2" * 3/4" - 2 τμχ
6. Κουτί ποιότητας, εγγύηση και οδηγίες χρήσης

Complete ready-to-install and operating kit including:

1. Compact single handle mixer for normal outdoor installation including magnetic shower holder.
 - Central distance for instalation - 10 cm;
 - 25 mm ceramic cartage - THS by Sedal;
2. Metal hygienic stop shower 1/2 " with magnetic head required for attaching to the body;
3. Shower hose 1/2 "120 cm with double braid and brass nuts. The hose has ANTI-TWIST function, which prevents the hose from twisting;
4. Massive brass rosettes with a diameter of 60 mm and a depth of 21 mm - 2 pcs;
5. Connection eccentrics 1/2 " * 3/4" - 2 pcs;
6. Luxury box, warranty card and manual instruction.



Μαγνητική Βάση για το ντους.
Magnetic attachment of the stop shower.

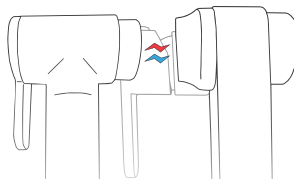

ΧΡΩΜΑ Color	ΚΩΔΙΚΟΣ Item №	Barcode		ΤΙΜΗ
ΜΑΥΡΟ MAT / Black matt	8486	3800154032523	1/20	154,29
ΧΡΩΜΕ / Chrome	8487	3800154032530	1/20	116,22



ΜΠΑΤΑΡΙΕΣ ΟΡΕΙΧΑΛΚΙΝΕΣ BRASS MIXERS

PHILIPOPOLIS



ΚΩΔΙΚΟΣ Item №	Barcode		ΤΙΜΗ
99659	3800154047091	1/10	103,62



ΚΩΔΙΚΟΣ Item №	Barcode		ΤΙΜΗ
99660	3800154047114	1/10	80,51



ΚΩΔΙΚΟΣ Item №	Barcode		ΤΙΜΗ
99658	3800154047077	1/10	77,84

PLISKA BLACK



ΚΩΔΙΚΟΣ Item №	Barcode		ΤΙΜΗ
99683	3800154047565	1/10	163,12



ΚΩΔΙΚΟΣ Item №	Barcode		ΤΙΜΗ
99682	3800154047541	1/10	136,63

PLISKA WHITE



ΚΩΔΙΚΟΣ Item №	Barcode		ΤΙΜΗ
99685	3800154047596	1/10	163,12



ΚΩΔΙΚΟΣ Item №	Barcode		ΤΙΜΗ
99684	3800154047572	1/10	144,55

TMS[®]
THERMOSTYLE



ZLATOGRAD



ΚΩΔΙΚΟΣ Item №	Barcode		TIMH
99686	3800154047626	1/10	164,56



ΚΩΔΙΚΟΣ Item №	Barcode		TIMH
99688	3800154047664	1/10	125,45



ΚΩΔΙΚΟΣ Item №	Barcode		TIMH
99687	3800154047640	1/10	129,90

NIKOPOL



ΚΩΔΙΚΟΣ Item №	Barcode		TIMH
99639	3800154046896	1/10	105,85



ΚΩΔΙΚΟΣ Item №	Barcode		TIMH
99640	3800154046919	1/10	79,18



ΚΩΔΙΚΟΣ Item №	Barcode		TIMH
99638	3800154046872	1/10	71,55

KALOFER



ΚΩΔΙΚΟΣ Item №	Barcode		TIMH
99642	3800154046933	1/10	83,60



ΚΩΔΙΚΟΣ Item №	Barcode		TIMH
99650	3800154046971	1/10	60,50



ΚΩΔΙΚΟΣ Item №	Barcode		TIMH
99649	3800154046957	1/10	54,18



ΜΠΑΤΑΡΙΕΣ ΟΡΕΙΧΑΛΚΙΝΕΣ
BRASS MIXERS

SEXAGINTA PRISTA



ΚΩΔΙΚΟΣ Item №	Barcode		TIMH
99680	3800154047503	1/10	126,31



ΚΩΔΙΚΟΣ Item №	Barcode		TIMH
99681	3800154047527	1/10	100,45



ΚΩΔΙΚΟΣ Item №	Barcode		TIMH
99679	3800154047480	1/10	76,01

SERDIKA



ΚΩΔΙΚΟΣ Item №	Barcode		TIMH
99690	3800154047701	1/10	89,87



ΚΩΔΙΚΟΣ Item №	Barcode		TIMH
99691	3800154047725	1/10	67,18



ΚΩΔΙΚΟΣ Item №	Barcode		TIMH
99689	3800154047688	1/10	70,19

SREDEC



ΚΩΔΙΚΟΣ Item №	Barcode		TIMH
99674	3800154047374	1/10	135,22



ΚΩΔΙΚΟΣ Item №	Barcode		TIMH
99676	3800154047428	1/10	114,34



ΚΩΔΙΚΟΣ Item №	Barcode		TIMH
99675	3800154047404	1/10	108,00

SOFIA



ΚΩΔΙΚΟΣ Item №	Barcode		ΤΙΜΗ
99662	3800154047152	1/10	76,95



ΚΩΔΙΚΟΣ Item №	Barcode		ΤΙΜΗ
99661	3800154047138	1/10	51,95



ΚΩΔΙΚΟΣ Item №	Barcode		ΤΙΜΗ
99664	3800154047190	1/10	78,29



ΚΩΔΙΚΟΣ Item №	Barcode		ΤΙΜΗ
99663	3800154047176	1/10	64,50

DOROSTOL



ΚΩΔΙΚΟΣ Item №	Barcode		ΤΙΜΗ
99672	3800154047343	1/10	146,77

ODESSUS



ΚΩΔΙΚΟΣ Item №	Barcode		ΤΙΜΗ
99673	3800154047350	1/10	56,51



ΜΠΑΤΑΡΙΕΣ ΟΡΕΙΧΑΛΚΙΝΕΣ
BRASS MIXERS

TERVEL



ΚΩΔΙΚΟΣ Item №	Barcode		ΤΙΜΗ
99654	3800154046995	1/10	76,95



ΚΩΔΙΚΟΣ Item №	Barcode		ΤΙΜΗ
99655	3800154047015	1/10	54,18



ΚΩΔΙΚΟΣ Item №	Barcode		ΤΙΜΗ
99657	3800154047053	1/10	74,30



ΚΩΔΙΚΟΣ Item №	Barcode		ΤΙΜΗ
99656	3800154047039	1/10	60,97

TAURUS



ΚΩΔΙΚΟΣ Item №	Barcode		ΤΙΜΗ
99668	3800154047282	1/10	65,40



ΚΩΔΙΚΟΣ Item №	Barcode		ΤΙΜΗ
99669	3800154047305	1/10	52,48



ΚΩΔΙΚΟΣ Item №	Barcode		ΤΙΜΗ
99667	3800154047268	1/10	43,96



BALCHIK



ΚΩΔΙΚΟΣ Item №	Barcode		ΤΙΜΗ
99677	3800154047442	1/10	154,32

ΚΩΔΙΚΟΣ Item №	Barcode		ΤΙΜΗ
99678	3800154047466	1/10	127,67



ΟΛΑ ΤΑ ΣΕΤ ΠΕΡΙΛΑΜΒΑΝΟΥΝ

All sets include:

NEOPERL water saving aerators

SEDAL ceramic cartage

TUCAI flexible hoses

Mounting kit

POP-UP (when is on the picture)

luxury box

Warranty card

ΜΠΑΤΑΡΙΕΣ ΟΡΕΙΧΑΛΚΙΝΕΣ BRASS MIXERS

ΜΕ ΜΗΧΑΝΙΣΜΟ SEDAL

ΜΠΑΤΑΡΙΑ ΛΟΥΤΡΟΥ AQUARIUS
BATHTUB MIXER FAUCET AQUARIUS



ΔΙΑΣΤΑΣΗ Dimension	ΚΩΔΙΚΟΣ Item №	Barcode		ΤΙΜΗ
Ø 40	8900	3800154016097	1/12	72,36

ΜΠΑΤΑΡΙΑ ΝΙΠΤΗΡΟΣ AQUARIUS
AQUARIUS BATHROOM DECK-MOUNT SINK MIXER FAUCET



ΔΙΑΣΤΑΣΗ Dimension	ΚΩΔΙΚΟΣ Item №	Barcode		ΤΙΜΗ
Ø 40	830	3800154016141	1/12	45,17

ΜΠΑΤΑΡΙΑ ΝΙΠΤΗΡΟΣ ΤΟΙΧΟΥ AQUARIUS
WALL-MOUNT SINK MIXER FAUCET AQUARIUS



ΔΙΑΣΤΑΣΗ Dimension	ΚΩΔΙΚΟΣ Item №	Barcode		ΤΙΜΗ
Ø 40 16 cm spout	8901	3800154016103	1/12	56,17
Ø 40 18 cm spout	8902	3800154016110	1/12	56,49
Ø 40 22 cm spout	8903	3800154016127	1/12	57,56

ΜΠΑΤΑΡΙΑ ΚΟΥΖΙΝΑΣ AQUARIUS
DECK-MOUNT KITCHEN MIXER FAUCET AQUARIUS



ΔΙΑΣΤΑΣΗ Dimension	ΚΩΔΙΚΟΣ Item №	Barcode		ΤΙΜΗ
Ø 40	99670	3800154047329	1/10	71,71

ΜΠΑΤΑΡΙΑ ΚΟΥΖΙΝΑΣ AQUARIUS
DECK-MOUNT KITCHEN MIXER FAUCET AQUARIUS



ΔΙΑΣΤΑΣΗ Dimension	ΚΩΔΙΚΟΣ Item №	Barcode		ΤΙΜΗ
Ø 40	888	3800154016134	1/12	50,04
Ø 40	10249	3800154041488	1/12	48,68

ΜΠΑΤΑΡΙΑ ΚΟΥΖΙΝΑΣ AQUARIUS
DECK-MOUNT KITCHEN MIXER FAUCET AQUARIUS



ΔΙΑΣΤΑΣΗ Dimension	ΚΩΔΙΚΟΣ Item №	Barcode		ΤΙΜΗ
Ø 40	8904	3800154016158	1/12	32,67



ΜΠΑΤΑΡΙΕΣ ΟΡΕΙΧΑΛΚΙΝΕΣ BRASS MIXERS

ΜΠΑΤΑΡΙΑ ΛΟΥΤΡΟΥ VITA
BRASS BATHTUB MIXER FAUCET VITA



ΔΙΑΣΤΑΣΗ Dimension	ΚΩΔΙΚΟΣ Item №	Barcode		ΤΙΜΗ
1/2"	8804	3800154016028	1/12	75,90

ΜΠΑΤΑΡΙΕΣ VITA
BRASS FAUCET DOUBLE HANDLE VITA



ΤΥΠΟΣ Type	ΚΩΔΙΚΟΣ Item №	Barcode		ΤΙΜΗ
ΡΟΥΞΟΥΝΙ R/ R SPOUT	8806	3800154016035	1/12	43,33
ΡΟΥΞΟΥΝΙ U/ U SPOUT	8807	3800154016042	1/12	43,33
ΡΟΥΞΟΥΝΙ S/ S SPOUT	8808	3800154016059	1/12	43,33
ΡΟΥΞΟΥΝΙ L/ L SPOUT	8809	3800154016066	1/12	43,33

ΜΠΑΤΑΡΙΑ VITA
BRASS FAUCET DOUBLE HANDLE VITA



ΤΥΠΟΣ Type	ΚΩΔΙΚΟΣ Item №	Barcode		ΤΙΜΗ
16 cm	991052	3800154040801	1/12	41,27
18 cm	991054	3800154041532	1/12	41,27
22 cm	991059	3800154040849	1/12	43,10

ΜΠΑΤΑΡΙΑ ΜΕ ΕΥΚΑΜΠΤΟ ΡΟΥΞΟΥΝΙ VITA
BRASS FAUCET-FLEXIBLE SPOUT VITA



ΔΙΑΣΤΑΣΗ Dimension	ΚΩΔΙΚΟΣ Item №	Barcode		ΤΙΜΗ
	991050	3800154041549	1/12	37,83

ΜΠΑΤΑΡΙΑ ΛΟΥΤΡΟΥ DALIA
BRASS BATHTUB MIXER FAUCET DALIA



ΔΙΑΣΤΑΣΗ Dimension	ΚΩΔΙΚΟΣ Item №	Barcode		ΤΙΜΗ
1/2"	8814	3800154015977	1/12	68,28

ΜΠΑΤΑΡΙΕΣ DALIA
BRASS FAUCET DOUBLE HANDLE DALIA



ΤΥΠΟΣ Type	ΚΩΔΙΚΟΣ Item №	Barcode		ΤΙΜΗ
ΡΟΥΞΟΥΝΙ R/ R SPOUT	8810	3800154015984	1/12	42,71
ΡΟΥΞΟΥΝΙ U/ U SPOUT	8811	3800154015991	1/12	42,71
ΡΟΥΞΟΥΝΙ S/ S SPOUT	8812	3800154016004	1/12	42,71
ΡΟΥΞΟΥΝΙ L/ L SPOUT	8813	3800154016011	1/12	42,71



ΜΠΑΤΑΡΙΕΣ ΟΡΕΙΧΑΛΚΙΝΕΣ BRASS MIXERS

ΜΠΑΤΑΡΙΑ DALIA
BRASS FAUCET DOUBLE HANDLE DALIA



ΤΥΠΟΣ Type	ΚΩΔΙΚΟΣ Item №	Barcode		ΤΙΜΗ
16 cm	991051	3800154040795	1/12	38,78
18 cm	991053	3800154040818	1/12	38,78
22 cm	991058	3800154040832	1/12	38,78

ΜΠΑΤΑΡΙΑ ΛΟΥΤΡΟΥ RETRO
BATHTUB MIXER FAUCET RETRO



ΔΙΑΣΤΑΣΗ Dimension	ΚΩΔΙΚΟΣ Item №	Barcode		ΤΙΜΗ
	87	3800154027222	1/12	84,44

ΜΠΑΤΑΡΙΑ ΛΟΥΤΡΟΥ ISKAR ΛΕΥΚΟ
BRASS BATHTUB MIXER FAUCET ISKAR WHITE



ΔΙΑΣΤΑΣΗ Dimension	ΚΩΔΙΚΟΣ Item №	Barcode		ΤΙΜΗ
	99101	3800154040597	1/12	59,53

ΜΠΑΤΑΡΙΑ ΜΕ ΕΥΚΑΜΠΤΟ ΡΟΥΞΟΥΝΙ DALIA
BRASS FAUCET-FLEXIBLE SPOUT DALIA



ΔΙΑΣΤΑΣΗ Dimension	ΚΩΔΙΚΟΣ Item №	Barcode		ΤΙΜΗ
	991049	3800154041457	1/12	36,37

ΜΠΑΤΑΡΙΕΣ RETRO
BRASS FAUCET DOUBLE HANDLE RETRO



ΤΥΠΟΣ Type	ΚΩΔΙΚΟΣ Item №	Barcode		ΤΙΜΗ
ΡΟΥΞΟΥΝΙ R/ R SPOUT	8114	3800154015915	1/12	44,15
ΡΟΥΞΟΥΝΙ U/ U SPOUT	8115	3800154015922	1/12	44,15
ΡΟΥΞΟΥΝΙ S/ S SPOUT	8118	3800154015946	1/12	44,15
ΡΟΥΞΟΥΝΙ L/ L SPOUT	8117	3800154015939	1/12	44,15

ΜΠΑΤΑΡΙΑ ISKAR ΛΕΥΚΟ
BRASS FAUCET DOUBLE HANDLE ISKAR WHITE



ΤΥΠΟΣ Type	ΚΩΔΙΚΟΣ Item №	Barcode		ΤΙΜΗ
ΡΟΥΞΟΥΝΙ R/ R SPOUT	99103	3800154040603	1/12	39,43
ΡΟΥΞΟΥΝΙ U/ U SPOUT	99102	3800154040610	1/12	39,43
ΡΟΥΞΟΥΝΙ S/ S SPOUT	99105	3800154040627	1/12	39,43
ΡΟΥΞΟΥΝΙ L/ L SPOUT	99104	3800154040634	1/12	39,43



ΜΠΑΤΑΡΙΕΣ ΟΡΕΙΧΑΛΚΙΝΕΣ BRASS MIXERS

ΜΠΑΤΑΡΙΑ ΙΣΚΑΡ ΛΕΥΚΟ
BRASS FAUCET DOUBLE HANDLE ISKAR WHITE



ΤΥΠΟΣ Type	ΚΩΔΙΚΟΣ Item №	Barcode		ΤΙΜΗ
16 cm	99106	3800154040658	1/12	43,57
18 cm	99107	3800154040665	1/12	43,57
22 cm	99108	3800154040672	1/12	43,57

ΜΠΑΤΑΡΙΑ ΜΕ ΕΥΚΑΜΠΤΟ ΡΟΥΞΟΥΝΙ ΙΣΚΑΡ ΛΕΥΚΟ
BRASS FAUCET-FLEXIBLE SPOUT ISKAR WHITE



ΔΙΑΣΤΑΣΗ Dimension	ΚΩΔΙΚΟΣ Item №	Barcode		ΤΙΜΗ
	991055	3800154040641	1/12	40,40

ΜΠΑΤΑΡΙΑ ΛΟΥΤΡΟΥ ΙΣΚΑΡ ΧΡΩΜΕ
BRASS BATHTUB MIXER FAUCET ISKAR CHROME



ΔΙΑΣΤΑΣΗ Dimension	ΚΩΔΙΚΟΣ Item №	Barcode		ΤΙΜΗ
	991010	3800154040689	1/12	61,41

ΜΠΑΤΑΡΙΑ ΙΣΚΑΡ ΧΡΩΜΕ
BRASS FAUCET DOUBLE HANDLE ISKAR CHROME



ΤΥΠΟΣ Type	ΚΩΔΙΚΟΣ Item №	Barcode		ΤΙΜΗ
16 cm	991017	3800154040740	1/12	45,48
18 cm	991018	3800154040757	1/12	45,48
22 cm	991019	3800154040764	1/12	45,48

ΜΠΑΤΑΡΙΑ ΙΣΚΑΡ ΧΡΩΜΕ
BRASS FAUCET DOUBLE HANDLE ISKAR CHROME



ΤΥΠΟΣ Type	ΚΩΔΙΚΟΣ Item №	Barcode		ΤΙΜΗ
ΡΟΥΞΟΥΝΙ R/ R SPOUT	991012	3800154040696	1/12	41,34
ΡΟΥΞΟΥΝΙ U/ U SPOUT	991016	3800154040702	1/12	41,34
ΡΟΥΞΟΥΝΙ S/ S SPOUT	991015	3800154040719	1/12	41,34
ΡΟΥΞΟΥΝΙ L/ L SPOUT	991011	3800154040726	1/12	41,34

ΜΠΑΤΑΡΙΑ ΜΕ ΕΥΚΑΜΠΤΟ ΡΟΥΞΟΥΝΙ ΙΣΚΑΡ ΧΡΩΜΕ
BRASS FAUCET-FLEXIBLE SPOUT ISKAR CHROME



ΔΙΑΣΤΑΣΗ Dimension	ΚΩΔΙΚΟΣ Item №	Barcode		ΤΙΜΗ
	991056	3800154040733	1/12	42,31

THS[®]
THERMOSTYLE



ΜΠΑΤΑΡΙΕΣ ΟΡΕΙΧΑΛΚΙΝΕΣ BRASS MIXERS

ΜΠΑΤΑΡΙΑ ΛΟΥΤΡΟΥ ROSITSA ΛΕΥΚΟ
BATH SHOWER DOUBLE HANDLE FAUCET ROSITSA WHITE



ΔΙΑΣΤΑΣΗ Dimension	ΚΩΔΙΚΟΣ Item №	Barcode		ΤΙΜΗ
1/2"	8574	3800154032691	1/24	57,64

ΜΠΑΤΑΡΙΕΣ ΚΟΥΖΙΝΑΣ ROSITSA ΛΕΥΚΟ
BATH SHOWER DOUBLE HANDLE FAUCET ROSITSA WHITE



ΤΥΠΟΣ Type	ΚΩΔΙΚΟΣ Item №	Barcode		ΤΙΜΗ
ΡΟΥΞΟΥΝΙ R/ R SPOUT	8575	3800154032707	1/24	37,60
ΡΟΥΞΟΥΝΙ U/ U SPOUT	8576	3800154032714	1/24	37,60
ΡΟΥΞΟΥΝΙ S/ S SPOUT	8577	3800154032721	1/24	37,60
ΡΟΥΞΟΥΝΙ L/ L SPOUT	8578	3800154032738	1/24	37,60

ΜΠΑΤΑΡΙΑ ΛΟΥΤΡΟΥ ROSITSA ΧΡΩΜΕ
BATH SHOWER DOUBLE HANDLE FAUCET ROSITSA CHROME



ΔΙΑΣΤΑΣΗ Dimension	ΚΩΔΙΚΟΣ Item №	Barcode		ΤΙΜΗ
1/2"	8579	3800154032745	1/24	60,50

ΜΠΑΤΑΡΙΕΣ ΚΟΥΖΙΝΑΣ ROSITSA ΧΡΩΜΕ
BATH SHOWER DOUBLE HANDLE FAUCET ROSITSA CHROME



ΤΥΠΟΣ Type	ΚΩΔΙΚΟΣ Item №	Barcode		ΤΙΜΗ
ΡΟΥΞΟΥΝΙ R/ R SPOUT	8580	3800154032752	1/24	40,43
ΡΟΥΞΟΥΝΙ U/ U SPOUT	8581	3800154032769	1/24	40,43
ΡΟΥΞΟΥΝΙ S/ S SPOUT	8582	3800154032776	1/24	40,43
ΡΟΥΞΟΥΝΙ L/ L SPOUT	8583	3800154032783	1/24	40,43

ΜΠΑΤΑΡΙΕΣ ΚΟΥΖΙΝΑΣ
KITCHEN MIXER FAUCET



ΤΥΠΟΣ Type	ΚΩΔΙΚΟΣ Item №	Barcode		ΤΙΜΗ
Dalia	88131	3800154029646	1/12	34,74
Vita	88091	3800154029431	1/12	40,56

ΜΠΑΤΑΡΙΕΣ ΚΟΥΖΙΝΑΣ
KITCHEN MIXER FAUCET



ΤΥΠΟΣ Type	ΚΩΔΙΚΟΣ Item №	Barcode		ΤΙΜΗ
Dalia	7512	3800154029554	1/12	25,34
Vita	7513	3800154029561	1/12	23,32



ΟΡΕΙΧΑΛΚΙΝΕΣ ΜΠΑΤΑΡΙΕΣ ΚΛΑΣΣΙΚΕΣ

BATHROOM EQUIPMENT

ΔΙΑΚΟΠΤΗΣ ΤΥΠΟΥ "ΚΑΝΟΥΛΑ"
STOP VALVE



ΔΙΑΣΤΑΣΗ Dimension	ΚΩΔΙΚΟΣ Item №	Barcode		ΤΙΜΗ
1/2" * 3/4"	8308	3800154032257	1/50	14,12

ΜΠΑΤΑΡΙΑ ΤΥΠΟΥ "U" ΜΕ ΦΙΛΤΡΟ ΕΞΟΙΚΟΝΟΜΙΣΗΣ ΝΕΡΟΥ
BRASS MIXER FAUCET WITH SPOUT U



ΤΥΠΟΣ Type	ΚΩΔΙΚΟΣ Item №	Barcode		ΤΙΜΗ
Dalia	7510	3800154029547	1/20	16,64
Vita	7511	3800154029530	1/20	19,94

UNGA ΜΠΑΤΑΡΙΑ ΤΟΙΧΟΥ ΑΝΑΜΙΚΤΙΚΗ
UNGA BRASS MIXER FAUCET SINGLE HANDLE THS by SEDAL



ΔΙΑΣΤΑΣΗ Dimension	ΚΩΔΙΚΟΣ Item №	Barcode		ΤΙΜΗ
Ø 35 THS by Sedal	7519	3800154029615	1/12	38,62

UNGA ΜΠΑΤΑΡΙΑ ΤΟΙΧΟΥ ΚΛΑΣΣΙΚΗ
UNGA BRASS MIXER FAUCET TWO HANDLES



ΔΙΑΣΤΑΣΗ Dimension	ΚΩΔΙΚΟΣ Item №	Barcode		ΤΙΜΗ
	7518	3800154029608	1/12	23,74



THS[®]
THERMOSTYLE



ΜΗΧΑΝΙΣΜΟΙ ΜΠΑΤΑΡΙΩΝ BATHROOM EQUIPMENT

ΜΗΧΑΝΙΣΜΟΣ ΚΕΡΑΜΙΚΟΣ ΜΕ ΠΟΔΙΑ CERAMIC CARTAGE WITH LEGS THS by SEDAL



ΔΙΑΣΤΑΣΗ Dimension	ΚΩΔΙΚΟΣ Item №	Barcode		ΤΙΜΗ
∅ 35	6710	3800154027147	1/100	6,10
∅ 40	6712	3800154027161	1/100	6,55

ΜΗΧΑΝΙΣΜΟΣ ΚΕΡΑΜΙΚΟΣ ΧΩΡΙΣ ΠΟΔΙΑ CERAMIC CARTAGE WITHOUT LEGS THS by SEDAL



ΔΙΑΣΤΑΣΗ Dimension	ΚΩΔΙΚΟΣ Item №	Barcode		ΤΙΜΗ
∅ 35	6711	3800154027154	1/200	6,10
∅ 40	6713	3800154027178	1/100	6,55

ΜΗΧΑΝΙΣΜΟΣ ΚΛΕΙΣΙΜΑΤΟΣ ΟΡΕΙΧΑΛΚΙΝΟΣ BRASS CARTAGE



ΔΙΑΣΤΑΣΗ Dimension	ΚΩΔΙΚΟΣ Item №	Barcode		ΤΙΜΗ
3/8"	92	3800154028304	10/500	1,31

ΜΗΧΑΝΙΣΜΟΣ ΚΛΕΙΣΙΜΑΤΟΣ ΚΕΡΑΜΙΚΟΣ BRASS CARTAGE TIK TAK



ΔΙΑΣΤΑΣΗ Dimension	ΚΩΔΙΚΟΣ Item №	Barcode		ΤΙΜΗ
1/2"	995	3800154014161	1/250	2,62
1/2"	910995	3800154029455	10/250	1,97

ΜΗΧΑΝΙΣΜΟΣ ΚΛΕΙΣΙΜΑΤΟΣ ΟΡΕΙΧΑΛΚΙΝΟΣ BRASS CARTAGE



ΔΙΑΣΤΑΣΗ Dimension	ΚΩΔΙΚΟΣ Item №	Barcode		ΤΙΜΗ
1/2"	91	3800154014178	1/500	2,75
1/2"	91091	3800154029448	10/250	2,49

ΜΗΧΑΝΙΣΜΟΣ ΚΛΕΙΣΙΜΑΤΟΣ ΜΕ ΟΛΟΚΛΗΡΟ ΛΑΣΤΙΧΟ BRASS CARTAGE WITH WHOLE BLACK RUBBER



ΔΙΑΣΤΑΣΗ Dimension	ΚΩΔΙΚΟΣ Item №	Barcode		ΤΙΜΗ
1/2"	9111	3800154021183	1/500	2,07
1/2"	9109111	3800154029462	10/500	1,86

ΜΗΧΑΝΙΣΜΟΣ ΚΛΕΙΣΙΜΑΤΟΣ RETRO BRASS CARTAGE RETRO



Размер Dimension	ΚΩΔΙΚΟΣ Item №	Barcode		ΤΙΜΗ
1/2"	9187	3800154016400	1/250	2,24





THS[®]
THERMOSTYLE



ΛΑΒΕΣ ΜΠΑΤΑΡΙΩΝ BATHROOM EQUIPMENT



ΜΕΤΑΛΛΙΚΗ ΛΑΒΗ RETRO METAL HANDLE RETRO



ΔΙΑΣΤΑΣΗ Dimension	ΚΩΔΙΚΟΣ Item N°	Barcode		TIMH
1/2"	989	3800154014338		3,41



ΜΕΤΑΛΛΙΚΗ ΛΑΒΗ RETRO 2TMX METAL HANDLE RETRO 2 PCS



ΔΙΑΣΤΑΣΗ Dimension	ΚΩΔΙΚΟΣ Item N°	Barcode		TIMH
1/2"	6765	3800154028328		11,24



ΣΕΤ ΜΗΧΑΝΙΣΜΟΥ ΚΛΕΙΣΙΜΑΤΟΣ ΜΕ ΛΑΒΗ ELI SET BRASS CARTAGE WITH HANDLE ELI



ΔΙΑΣΤΑΣΗ Dimension	ΚΩΔΙΚΟΣ Item N°	Barcode		TIMH
3/8"	9293	3800154014185		2,17

ΣΕΤ ΜΗΧΑΝΙΣΜΟΥ ΚΛΕΙΣΙΜΑΤΟΣ ΜΕ ΛΑΒΗ UNGA SET WITH CARTAGE AND PLASTIC HANDLE TRIANGLE FOR UNGA



ΔΙΑΣΤΑΣΗ Dimension	ΚΩΔΙΚΟΣ Item N°	Barcode		TIMH
3/8"	7520	3800154029622		2,12



ΣΕΤ ΜΗΧΑΝΙΣΜΟΥ ΚΛΕΙΣΙΜΑΤΟΣ ΜΕ ΛΑΒΗ VITA SET BRASS CARTAGE WITH HANDLE VITA



ΔΙΑΣΤΑΣΗ Dimension	ΚΩΔΙΚΟΣ Item N°	Barcode		TIMH
1/2"	6767	3800154028342		4,53

ΣΕΤ ΜΗΧΑΝΙΣΜΟΥ ΚΛΕΙΣΙΜΑΤΟΣ ΜΕ ΛΑΒΗ DALIA SET BRASS CARTAGE WITH HANDLE DALIA



ΔΙΑΣΤΑΣΗ Dimension	ΚΩΔΙΚΟΣ Item N°	Barcode		TIMH
1/2"	6766	3800154028359		3,46

TMS
THERMOSTYLE



ΛΑΒΕΣ ΜΠΑΤΑΡΙΩΝ BATHROOM EQUIPMENT

ΠΛΑΣΤΙΚΗ ΛΑΒΗ ΕΛΙ PLASTIC HANDLE ELI



ΔΙΑΣΤΑΣΗ Dimension	ΚΩΔΙΚΟΣ Item Nº	Barcode		ΤΙΜΗ
3/8"	93	3800154028311	10/100	0,76

ΜΕΤΑΛΛΙΚΗ ΛΑΒΗ ΒΙΤΑ METAL HANDLE VITA



ΔΙΑΣΤΑΣΗ Dimension	ΚΩΔΙΚΟΣ Item Nº	Barcode		ΤΙΜΗ
1/2"	996	3800154014239	20/200	3,51

ΜΕΤΑΛΛΙΚΗ ΛΑΒΗ ΒΙΤΑ 2ΤΜΧ METAL HANDLE VITA 2 PCS



ΔΙΑΣΤΑΣΗ Dimension	ΚΩΔΙΚΟΣ Item Nº	Barcode		ΤΙΜΗ
1/2"	6764	3800154028335	1/200	5,66

ΠΛΑΣΤΙΚΗ ΛΑΒΗ ΔΑΛΙΑ PLASTIC HANDLE DALIA



ΔΙΑΣΤΑΣΗ Dimension	ΚΩΔΙΚΟΣ Item Nº	Barcode		ΤΙΜΗ
1/2"	96	3800154014208	10/250	1,73

ΠΛΑΣΤΙΚΗ ΛΑΒΗ ΔΑΛΙΑ 2ΤΜΧ PLASTIC HANDLE DALIA 2 PCS



ΔΙΑΣΤΑΣΗ Dimension	ΚΩΔΙΚΟΣ Item Nº	Barcode		ΤΙΜΗ
1/2"	6716	3800154027208	1/200	4,53

ΣΕΤ ΜΗΧΑΝΙΣΜΟΥ ΚΛΕΙΣΙΜΑΤΟΣ ΜΕ ΛΑΒΗ RETRO SET BRASS CARTAGE RETRO WITH HANDLE RETRO



ΔΙΑΣΤΑΣΗ Dimension	ΚΩΔΙΚΟΣ Item Nº	Barcode		ΤΙΜΗ
1/2"	6768	3800154028366	1/50	8,02



ΛΑΒΕΣ ΜΠΑΤΑΡΙΩΝ ACCESSORIES FOR MIXERS

ΣΕΤ ABM ΧΡΩΜΕ SET ABM CHROME



ΔΙΑΣΤΑΣΗ Dimension	ΚΩΔΙΚΟΣ Item N°	Barcode		ΤΙΜΗ
1/2"	9192	3800154034923		4,56
1/2"	9191	3800154034916		4,69

ΣΕΤ ABM ΛΕΥΚΟ SET ABM WHITE



ΔΙΑΣΤΑΣΗ Dimension	ΚΩΔΙΚΟΣ Item N°	Barcode		ΤΙΜΗ
1/2"	9190	3800154034909		2,86
1/2"	9189	3800154034893		3,75

ΣΕΤ ROSITSA ΧΡΩΜΕ SET ROSITSA CHROME



ΔΙΑΣΤΑΣΗ Dimension	ΚΩΔΙΚΟΣ Item N°	Barcode		ΤΙΜΗ
1/2"	9195	3800154034954		4,40
1/2"	9196	3800154034961		4,19

ΣΕΤ ROSITSA ΛΕΥΚΟ SET ROSITSA WHITE



ΔΙΑΣΤΑΣΗ Dimension	ΚΩΔΙΚΟΣ Item N°	Barcode		ΤΙΜΗ
1/2"	9193	3800154034930		2,96
1/2"	9194	3800154034947		2,96

ΣΕΤ ISKAR ΧΡΩΜΕ SET ISKAR CHROME



ΔΙΑΣΤΑΣΗ Dimension	ΚΩΔΙΚΟΣ Item N°	Barcode		ΤΙΜΗ
1/2"	9200	3800154035005		4,56
1/2"	9199	3800154034992		3,98

ΣΕΤ ISKAR ΛΕΥΚΟ SET ISKAR WHITE



ΔΙΑΣΤΑΣΗ Dimension	ΚΩΔΙΚΟΣ Item N°	Barcode		ΤΙΜΗ
1/2"	9197	3800154034978		4,06
1/2"	9198	3800154034985		3,48

ΔΙΑΦΟΡΑ ΕΞΑΡΤΗΜΑΤΑ BATHROOM EQUIPMENT

ΣΕΤ ΕΓΚΑΤΑΣΤΑΣΗΣ ΟΡΕΙΧΑΛΚΙΝΟ ΓΙΑ ΚΑΘΕΤΗ ΜΠΑΤΑΡΙΑ SCREW, O-RING, RUBBER WASHER, BRASS



ΔΙΑΣΤΑΣΗ Dimension	ΚΩΔΙΚΟΣ Item №	Barcode		ΤΙΜΗ
1 ΤΡΥΠΑ/ 1 hole	7508	3800154029523		2,78
2 ΤΡΥΠΕΣ/ 2 holes	7509	3800154029516		2,78

ΦΙΛΤΡΟ ΜΠΑΤΑΡΙΑΣ ΕΞΟΙΚΟΝΟΜΗΣΗΣ ΝΕΡΟΥ WATERSAVING AERATOR



ΔΙΑΣΤΑΣΗ Dimension	ΚΩΔΙΚΟΣ Item №	Barcode		ΤΙΜΗ
Ø 22 mm	6714	3800154027185		1,15
Ø 24 mm	6715	3800154027192		1,15

ΠΑΞΙΜΑΔΙ ΜΠΑΤΑΡΙΑΣ ΟΡΕΙΧΑΛΚΙΝΟ ΧΡΩΜΕ BRASS NUT FOR FAUCET



ΔΙΑΣΤΑΣΗ Dimension	ΚΩΔΙΚΟΣ Item №	Barcode		ΤΙΜΗ
3/4"	914	3800154014468		119,00

ΡΑΚΟΡ ΣΥΓΚΡΑΤΗΣΗΣ ΓΙΑ ΠΑΞΙΜΑΔΙ ΜΠΑΤΑΡΙΑΣ SS BED FOR FAUCET



ΔΙΑΣΤΑΣΗ Dimension	ΚΩΔΙΚΟΣ Item №	Barcode		ΤΙΜΗ
	992	3800154016264		0,97

ΕΚΚΕΝΤΡΟ ΣΙΓΜΑ BRASS ELBOW FOR FAUCET



ΔΙΑΣΤΑΣΗ Dimension	ΚΩΔΙΚΟΣ Item №	Barcode		ΤΙΜΗ
3/4" * 1/2"	928	3800154014437		2,49

ΡΟΖΕΤΑ ΧΡΩΜΕ ROSETTE BRASS CHROME PLATED



ΔΙΑΣΤΑΣΗ Dimension	ΚΩΔΙΚΟΣ Item №	Barcode		ΤΙΜΗ
3/4"	9271	3800154014444		1,49

ΚΑΛΥΜΜΑ ΓΙΑ ΧΕΡΟΥΛΙ RETRO COVER FOR HANDLE RETRO



ΔΙΑΣΤΑΣΗ Dimension	ΚΩΔΙΚΟΣ Item №	Barcode		ΤΙΜΗ
	7245	3800154029486		1,10

TMS
THERMOSTYLE



ΕΥΚΑΜΠΤΟ ΣΤΟΜΙΟ ΜΕ ΝΤΟΥΣ FLEXIBLE SPOUT



ΔΙΑΣΤΑΣΗ Dimension	ΚΩΔΙΚΟΣ Item №	Barcode		ΤΙΜΗ
1/2"	993	3800154016561	1/50	7,07

ΣΤΟΜΙΟ ΓΙΑ ΡΟΥΞΟΥΝΙ SPREADING SHOWER FOR SPOUT



ΔΙΑΣΤΑΣΗ Dimension	ΚΩΔΙΚΟΣ Item №	Barcode		ΤΙΜΗ
∅ 22	6717	3800154027215	1/250	2,41

ΤΗΛΕΦΩΝΟ ΝΤΟΥΣ Β.Τ. RETRO SHOWER, HEAVY TYPE



ΤΥΠΟΣ Type:	ΚΩΔΙΚΟΣ Item №	Barcode		ΤΙΜΗ
ΡΕΤΡΟ / Retro	912	3800154029479	1/100	9,43
Anti Limestone	9910	3800154018695	1/50	2,20

ΑΝΤΑΛΛΑΚΤΙΚΟ ΡΟΥΞΟΥΝΙ BRASS SPOUT FOR FAUCET AND WATERSAVING AERATOR



ΔΙΑΣΤΑΣΗ Dimension	ΚΩΔΙΚΟΣ Item №	Barcode		ΤΙΜΗ
35 cm	99665	3800154047220	1/100	12,45
40 cm	99666	3800154047237	1/100	12,45

ΣΤΟΜΙΟ ΜΠΑΤΑΡΙΑΣ ΜΕ ΦΙΛΤΡΟ ΕΞΟΙΚΟΝΟΜΙΣΗΣ ΝΕΡΟΥ STAINLESS SPOUT WITH WATER SAVING AERATOR



ΔΙΑΣΤΑΣΗ Dimension	ΚΩΔΙΚΟΣ Item №	Barcode		ΤΙΜΗ
ΡΟΥΞΟΥΝΙ R/ R SPOUT	9640	3800154029578	1/200	4,72
ΡΟΥΞΟΥΝΙ U/ U SPOUT	9660	3800154029585	1/200	4,72
ΡΟΥΞΟΥΝΙ S/ S SPOUT	9650	3800154029592	1/200	4,72
ΡΟΥΞΟΥΝΙ L/ L SPOUT	9670	3800154029639	1/200	4,72

ΣΤΟΜΙΟ ΜΠΑΤΑΡΙΑΣ AQUARIUS ΜΕ ΦΙΛΤΡΟ ΕΞΟΙΚΟΝΟΜΙΣΗΣ ΝΕΡΟΥ BRASS SPOUT FOR AQUARIUS FAUCET AND WATERSAVING AERATOR



ΔΙΑΣΤΑΣΗ Dimension	ΚΩΔΙΚΟΣ Item №	Barcode		ΤΙΜΗ
16 cm	99316	3800154016172	1/100	8,23
18 cm	99318	3800154016189	1/100	8,23
22 cm	99322	3800154016196	1/100	8,23



ΕΠΕΚΤΙΝΟΜΕΝΟ ΑΝΟΞΕΙΔΩΤΟ ΣΠΙΡΑΛ ΑΝΤΙ-TWIST GOLD SHOWER HOSE EXTENDABLE ANTI-TWIST GOLD



ΔΙΑΣΤΑΣΗ Dimension	ΚΩΔΙΚΟΣ Item №	Barcode		ΤΙΜΗ
1/2" - 120-150 cm	6836	3800154028649	1/25	8,72

ΕΠΕΚΤΙΝΟΜΕΝΟ ΑΝΟΞΕΙΔΩΤΟ ΣΠΙΡΑΛ ΑΝΤΙ-TWIST SILVER SHOWER HOSE EXTENDABLE ANTI-TWIST SILVER



ΔΙΑΣΤΑΣΗ Dimension	ΚΩΔΙΚΟΣ Item №	Barcode		ΤΙΜΗ
1/2" - 175-220 cm	6835	3800154028632	1/25	8,31

ΣΠΙΡΑΛ ΑΝΤΙ-TWIST ΜΑΥΡΟ SHOWER TUBE PVC ANTITWIST BLACK



ΔΙΑΣΤΑΣΗ Dimension	ΚΩΔΙΚΟΣ Item №	Barcode		ΤΙΜΗ
1/2" - 175 cm	7728	3800154031359	1/25	19,31

ΣΠΙΡΑΛ ΑΝΤΙ-TWIST ΧΡΥΣΟ SHOWER TUBE PVC ANTITWIST GOLD



ΔΙΑΣΤΑΣΗ Dimension	ΚΩΔΙΚΟΣ Item №	Barcode		ΤΙΜΗ
1/2" - 175 cm	7726	3800154031342	1/25	19,31

ΣΠΙΡΑΛ ΑΝΤΙ-TWIST ΑΣΗΜΙ SHOWER TUBE PVC ANTITWIST SILVER



ΔΙΑΣΤΑΣΗ Dimension	ΚΩΔΙΚΟΣ Item №	Barcode		ΤΙΜΗ
1/2" - 175 cm	7725	3800154031335	1/25	18,21

ΔΙΑΝΟΜΕΑΣ ΣΤΗΛΗΣ ΝΤΟΥΣ DIVERTER BRASS CHROME PLATED



ΔΙΑΣΤΑΣΗ Dimension	ΚΩΔΙΚΟΣ Item №	Barcode		ΤΙΜΗ
3/4"	958	3800154014369	1/100	11,69



СИФОН ЗА МИВКА НЕРЪЖДАЕМ БЕЗ ВИТЛО
BOTTLE ROUND TRAP WITHOUT POP UP



Размер Dimension	Арт. № Item №	Баркод Barcode		TIMH
1 1/4"	9996	3800154040498	1/25	16,64

СИФОН ЗА МИВКА НЕРЪЖДАЕМ БЕЗ ВИТЛО
BOTTLE ROUND TRAP WITHOUT POP UP



Размер Dimension	Арт. № Item №	Баркод Barcode		TIMH
1 1/4"	9998	3800154040511	1/25	33,77

СИФОН ЗА МИВКА НЕРЪЖДАЕМ С ВИТЛО
BOTTLE ROUND TRAP WITH BRASS TAP



Размер Dimension	Арт. № Item №	Баркод Barcode		TIMH
1 1/4"	1067	3800154013423	1/25	16,09

СИФОН ЗА МИВКА НЕРЪЖДАЕМ БЕЗ ВИТЛО
BOTTLE ROUND TRAP WITH OUT POP UP



Размер Dimension	Арт. № Item №	Баркод Barcode		TIMH
1 1/4"	9997	3800154040504	1/25	26,23

ВИТЛО КЛИК ЗА МИВКА МЕСИНГ
BRASS TIK TAK TAP FOR SINK



Размер Dimension	Арт. № Item №	Баркод Barcode		TIMH
1 1/4"	1069	3800154016806	1/45	10,32
1 1/4"	10692	3800154004131	1/45	10,61
1 1/4" 68/68мм	9942	3800154040481	1/45	12,63
1 1/4" 68/68мм	99421	3800154004148	1/45	15,35

ГОФРИРАНА ВРЪЗКА НЕРЪЖДАВЕЙКА ХРОМ
METAL TUBE SS



Размер Dimension	Арт. № Item №	Баркод Barcode		TIMH
1 1/4"	10531	3800154016790	1/50	9,59



ΠΟΔΩ ΣΙΦΟΝ С ΚΛΑΠΑ СΕΡΙΑ BLACKMATT
BOTTLE ROUND TRAP WITHOUT POP UP



Размер Dimension	Αрт. № Item №	Баркод Barcode		TIMH
100*100 mm/ Ø 50	9971	3800154004278	1/40	22,11

ΠΟΔΩ ΣΙΦΟΝ С ΚΛΑΠΑ СΕΡΙΑ RAINBOW
BOTTLE SQUARED TRAP WITHOUT POP UP

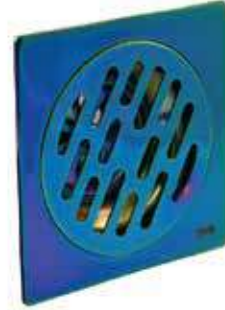

Размер Dimension	Αрт. № Item №	Баркод Barcode		TIMH
100*100 mm/ Ø 50	99613	3800154004193	1/40	26,15

СИΦΟΝ ΡΟΓΩВ ΜΕΣΙΝΓ ΧΡΟΜ ΚΒΑΔΡΑΤ
BRASS COVERED FLOOR ANGLE DRAIN

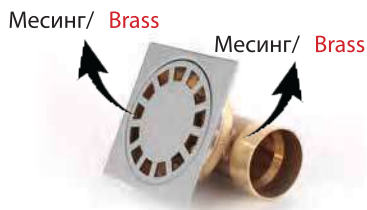

Размер Dimension	Αрт. № Item №	Баркод Barcode		TIMH
100*100 mm/ Ø 50	1082	3800154013829	1/50	23,34

СИΦΟΝ ΠΡΑВ ΜΕΣΙΝΓ ΚΒΑΔΡΑΤ
BRASS FLOOR STRAIGHT DRAIN

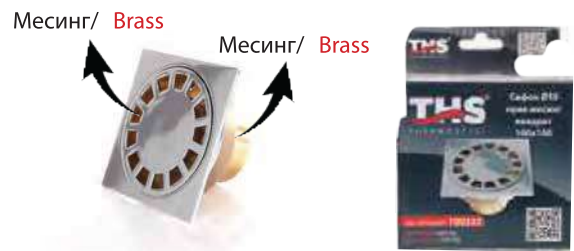

Размер Dimension	Αрт. № Item №	Баркод Barcode		TIMH
100*100 mm/ Ø 50	100333	3800154016783	1/50	17,55

ΤΑΠΑ ЗА ΜΙВΚΑ
COVER TAP DECORATIVE FOR SINK



Размер Dimension	Αрт. № Item №	Баркод Barcode		TIMH
	7912	3800154013492	10/200	2,04
	791	3800154013485	10/200	2,04

ΒΙΤΛΟ ΜΕΣΙΝΓΟΒΟ
BRASS TAP FOR SINK



Размер Dimension	Αрт. № Item №	Баркод Barcode		TIMH
1 1/4"	108	3800154013430	1/100	5,06
1 1/2"	10812	3800154016417	1/100	5,71

ННМА - УГРО ТЕФЛОН - КАНАВИ PTFE AND HACKLED FLAX

ТЕФЛОНОВА ЛЕНТА ЖЪЛТА ЗА ГАЗ ПРОФЕСИОНАЛНА PTFE YELLOW TAPE



Размер Dimension	Арт. № Item №	Баркод Barcode		TIMH
12mm*0,1mm*12 meters	5781	3800154022258		0,86
19mm*0,2mm*15 meters.t	5782	3800154022265		2,25
25mm*0,1mm*50 meters	5783	3800154022272		3,72

ТЕФЛОНОВ КОНЕЦ PTFE



Размер Dimension	Арт. № Item №	Баркод Barcode		TIMH
80 метра/meters	6100	3800154022432		4,14
150 метра/meters	6101	3800154022449		8,65

ТЕЧЕН ТЕФЛОН LIQUID PTFE



Размер Dimension	Арт. № Item №	Баркод Barcode		TIMH
50 ml	6102	3800154022456		5,24
250 ml	6103	3800154022463		9,85

КЪЛЧИЦА HACKLED FLAX (HAMP)



Тегло Weight	Арт. № Item №	Баркод Barcode		TIMH
±60 гр./g.	478	3800154002465		1,83
±100 гр./g.	4782	3800154024122		3,41
± 200 гр./g.	4784	3800154032561		6,60
± 250 гр./g.	4785	3800154032578		8,20
± 40 гр./g.	4786	3800154032585		1,89
± 80 гр./g.	4783	3800154024139		3,51

НОЖИЦА ЗА ППР АВТОМАТИК CUTTER FOR PPR AUTOMATIC



Размер Dimension	Арт. № Item №	Баркод Barcode		TIMH
Ø 20 - Ø 42	94500	3800154019357		13,23

КЪЛЧИЦА БАЛА 50 кг HACKLED FLAX (HAMP) MOQ 50 kg



Тегло Weight	Арт. № Item №	Баркод Barcode		TIMH
50 kg	4781			31,83

TMS[®]
THERMOSTYLE



ΘΕΡΜΑΝΣΗ
HEATING





Πλεονεκτήματα σωμάτων αλουμινίου

ADVANTAGES OF ALUMINIUM RADIATORS FOR BATHROOM

THS
THERMOSTYLE

THS
THERMOSTYLE

100% Αλουμίνιο

Το αλουμίνιο δεν διαβρώνεται
Δεν δημιουργείται σκουριά και λάσπη στο εσωτερικό
Πάντα καθαρό σύστημα

Υψηλή πίεση λειτουργίας PN16

12 χρόνια εγγύηση

Φίλικό προς το περιβάλλον

Εύκολη εγκατάσταση

Κατασκευασμένο στην Ευρωπαϊκή Ένωση

Το σετ περιλαμβάνει:

Στηρίγματα
Αυτόματο εξαεριστικό
Τάπα χρωμέ 1/2"

100 % Aluminium

Aluminum does not corrode;
No formation of rust and sludge inside the radiators;
No formation of rust and external corrosion;
Always clean water system.

High heat capacity

Absence of radishes and sludge inside radiators help for greater energy efficiency.

High working pressure resistant PN16

12 years product warranty

Ecologically friendly product

Only recycled metal is used for the product.

Comfortable and easy to install and transport

Unlike other metals, aluminium is light, which allows the aluminium radiators THS Thermostyle to be comfortable for installation and transportation.

Made in European Union

The set contains:

Fasteners;
Manual air vent;
End cap brass chrome plated with a seal 1/2".



CAYMAN



ΚΩΔΙΚΟΣ Item N	Barcode	ΤΙΜΗ	ΜΗΚΟΣ mm Width/mm	ΥΨΟΣ mm Height/mm	ΑΠΟΣΤΑΣΗ ΚΕΝΤΡΟΥ mm Centre distance/mm	ΠΕΡ/ΤΑ ΝΕΡΟΥ Water content/Lt.	Watt/ ΔΤ50°	Watt/ ΔΤ60°	ΧΡΩΜΑ Color
6839	3800154028670	182,69	432	600	400	2.65	286	352	Λευκό/White
6840	3800154028687	228,36	432	900	400	2.80	378	465	Λευκό/White
6841	3800154028694	258,80	432	900	400	2.80	378	465	Γκρι/Sandy grey
6842	3800154028700	258,80	432	900	400	2.80	378	465	Μαύρο/Sandy black
6843	3800154028717	282,02	432	1200	400	4.10	572	704	Λευκό/White
6844	3800154028724	308,64	432	1200	400	4.10	572	704	Γκρι/Sandy grey
6845	3800154028731	308,14	432	1200	400	4.10	572	704	Μαύρο/Sandy black
6846	3800154028748	334,91	432	1400	400	5.60	672	827	Λευκό/White
6848	3800154028762	334,91	532	1200	500	4.50	677	834	Λευκό/White
7624	3800154030222	365,36	532	1200	500	4.50	677	877	Γκρι/Sandy grey
7625	3800154030239	365,36	532	1200	500	4.50	677	877	Μαύρο/Sandy black

ΤΟΠΟΘΕΤΗΣΗ
INSTALLATION SCHEME

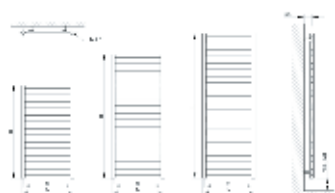



CLASSICA

ΚΛΑΣΙΚΑ



CHROME

BLACK

GOLD

ANTHRACITE

ΚΩΔΙΚΟΣ Item N°	Barcode	ΤΙΜΗ	ΜΗΚΟΣ mm width/mm	ΥΨΟΣ mm Height/mm	ΑΠΟΣΤΑΣΗ ΚΕΝΤΡΟΥ mm Centre distance/mm	ΠΕΡ/ΤΑΝΕΡΟΥ Water content/Lt.	Watt/ ΔT50°	Watt/ ΔT60°	ΧΡΩΜΑ Color
99625	3800154046148		400	900	368	3,00	374	426	Χρoμ/ Chrome
99793	3800154051203	106,61	400	900	368	3,00	374	426	Αντραцит/Anthracite
99626	3800154046155		400	1200	368	4,40	483	594	Χρoμ/ Chrome
99794	3800154051210	138,18	400	1200	368	4,40	483	594	Αντραцит/Anthracite
99623	3800154046124		500	800	468				Χρoμ/ Chrome
99795	3800154051227	103,02	500	800	468				Αντραцит/Anthracite
99699	3800154046162	130,42	500	900	468	3,4	450	597	Gold cappuccino
99796	3800154051234	150,02	500	1200	468	4,3	593	730	Αντραцит/Anthracite
99624	3800154046131		500	1200	468	4,3	593	730	Χρoμ/ Chrome





CLASSICA

Classic

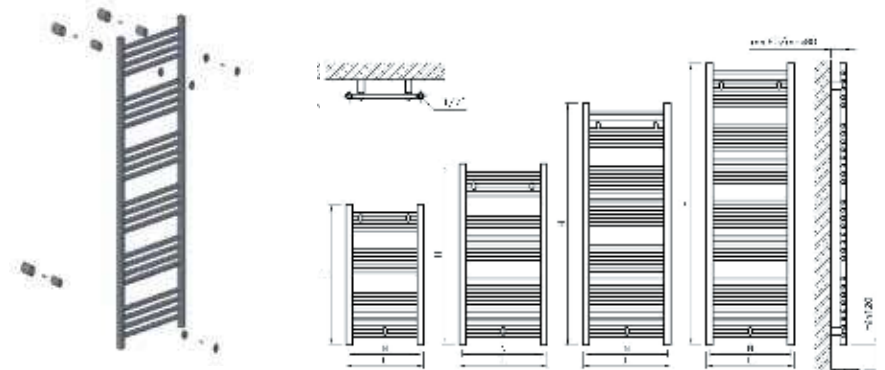

ΚΩΔΙΚΟΣ Item N°	Barcode	ΤΙΜΗ	ΜΗΚΟΣ Width/mm	ΥΨΟΣ Height/mm	ΑΠΟΣΤΑΣΗ ΑΠΟ ΚΕΝΤΡΑ Centre distance/mm	ΠΑΡΟΧΗ ΝΕΡΟΥ Water content/Lt	Watt/ ΔΤ50°	Watt/ ΔΤ60°
6849	3800154028779	105,74	400	900	368	3,00	347	426
6850	3800154028786	126,05	400	1200	368	4,40	483	594
6851	3800154028793	145,17	400	1400	368	5,10	620	762
6852	3800154028809	159,69	400	1600	368	6,20	709	872
6853	3800154028816	116,69	500	900	468	3,40	450	554
6854	3800154028823	150,31	500	1200	468	4,30	593	730
6855	3800154028830	158,59	500	1400	468	5,50	723	890
6856	3800154028847	122,56	600	900	568	3,65	548	675
6857	3800154028854	148,34	600	1200	568	4,90	701	863
6858	3800154028861	171,61	600	1400	568	5,90	832	1024



ORBIT

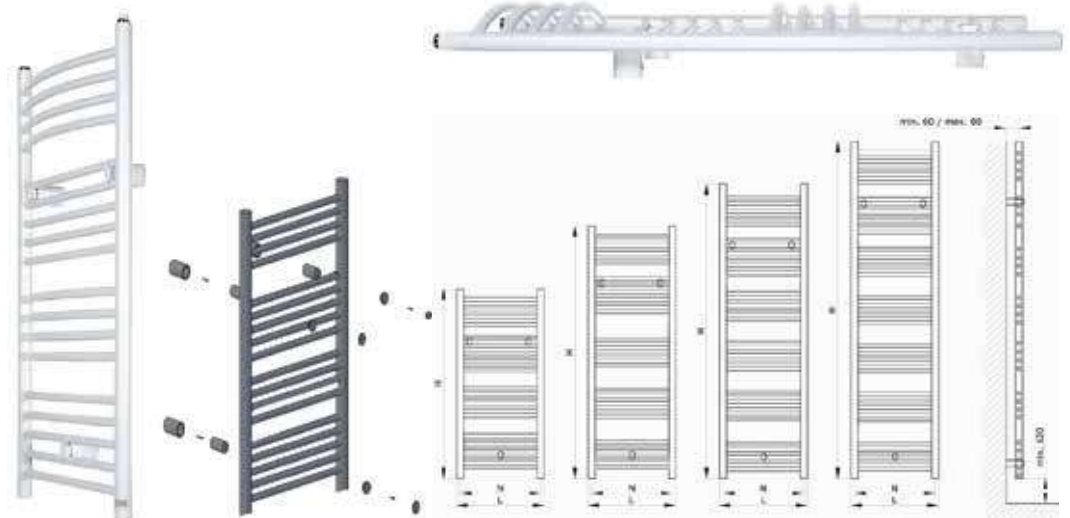

Αρτ. Νο Item N°	Barcode	ΤΙΜΗ	ΜΗΚΟΣ Width/mm	ΥΨΟΣ Height/mm	ΑΠΟΣΤΑΣΗ ΑΠΟ ΚΕΝΤΡΑ Centre distance/mm	ΠΑΡΟΧΗ ΝΕΡΟΥ Water content/Lt	Watt/ ΔΤ50°	Watt/ ΔΤ60°
6859	3800154028878	124,14	432	900	400	4,10	334	554
6860	3800154028885	159,30	432	1200	400	5,40	465	654
7629	3800154030277	134,62	532	900	500	4,50	554	693
7630	3800154030284	173,00	532	1200	500	5,90	631	820



ΗΛΕΚΤΡΙΚΕΣ ΠΕΤΣΕΤΟΚΡΕΜΑΣΤΡΕΣ ΑΛΟΥΜΙΝΙΟΥ ALUMINIUM ELECTRIC BATHROOM RADIATORS

THIS[®] DESIGN RADIATOR THERMOSTYLE SOFIA

ΣΥΓΧΡΟΝΟΣ ΣΧΕΔΙΑΣΜΟΣ

Οι ηλεκτρικές πετσετοκρεμάστρες SOFIA διαθέτουν σύγχρονο σχεδιασμό, υψηλή ποιότητα και ασφάλεια

ΠΡΑΚΤΙΚΗ ΛΥΣΗ

Οι ενσωματωμένοι πρακτικοί στεγνωτήρες στο μπροστινό μέρος της πετσετοκρεμάστρας SOFIA είναι κατάλληλοι για το στέγνωμα πετσετών ή ρούχων

ΥΨΗΛΗ ΠΟΙΟΤΗΤΑ

Οι ηλεκτρικές πετσετοκρεμάστρες SOFIA χρησιμοποιούνται αυτόνομα, χωρίς τη χρήση νερού ή άλλου θερμαντικού υγρού. Με αυτόν τον τρόπο εξαιρείται η πιθανότητα να παγώσουν ή να αυξηθεί η πίεση στο σώμα

ΑΣΦΑΛΗΣ ΘΕΡΜΑΝΣΗ

Το μπροστινό μέρος της πετσετοκρεμάστρας, είναι κατασκευασμένο από προφίλ αλουμινίου υψηλής ποιότητας που προσδίδει μία εμφάνιση πολυτέλειας με κομψές γραμμές. Η ηλεκτρική αντίσταση είναι ενσωματωμένη σε σωλήνες από ανοξείδωτο ατσάλι, συνδεδεμένες σε σταθερή κατασκευή που επιτρέπει μέγιστη και ομοιόμορφη θέρμανση του μπροστινού πάνελ

MODERN DESIGN

Modern design, high quality and safety are characteristics which recommend bathroom radiator SOFIA Electric.

PRACTICAL SOLUTION

Thanks to the usage of practical holders on the front surface, SOFIA Electric is also a dryer of towels and small clothing pieces.

HIGH QUALITY

The front part of the radiator is made of the high quality **aluminum profiles, giving this radiator a luxury look and elegant lines.** Electrical heater is integrated in the stainless steel tubes, which are connected into a solid construction enabling optimal and even heat expansion to the front panels.

SAFE ELECTRICAL HEATING

SOFIA Electric is a dry radiator not containing water nor **other heating fluid. This way the possibility of freezing or pressure expansion inside the heating body is avoided.**



ΘΕΡΜΑΝΣΗ HEATING

ΗΛΕΚΤΡΙΚΕΣ ΠΕΤΣΕΤΟΚΡΕΜΑΣΤΡΕΣ ΑΛΟΥΜΙΝΙΟΥ ALUMINIUM ELECTRIC RADIATORS

THS® DESIGN RADIATOR
SOFIA

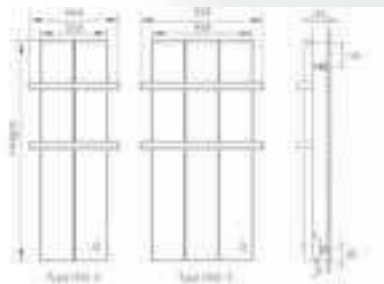

ΗΛΕΚΤΡΙΚΗ ΠΕΤΣΕΤΟΚΡΕΜΑΣΤΡΑ ΑΛΟΥΜΙΝΙΟΥ ΛΕΥΚΗ ALUMINIUM ELECTRIC TOWEL RADIATOR WHITE

ΚΩΔΙΚΟΣ Barcode	Barcode	ΤΙΜΗ	ΜΗΚΟΣ Width/mm	ΥΨΟΣ Height/mm	ΒΑΡΟΣ/ Weight	Watt	ΕΛΕΓΧΟΣ ΘΕΡΜΟΚΡΑΣΙΑΣ Temperature control	ΠΑΡΟΧΗ ΡΕΥΜΑΤΟΣ Power supply
7468	3800154029202	228,99	404	800	3,7	400	5÷85°C	220÷240V 50 Hz
7469	3800154029219	259,38	404	1000	4,6	500	5÷85°C	220÷240V 50 Hz
7470	3800154029226	297,63	558	800	5,6	600	5÷85°C	220÷240V 50 Hz
7471	3800154029233	358,94	558	1000	6,9	750	5÷85°C	220÷240V 50 Hz

ΣΤΕΓΝΩΤΗΡΑΣ ΛΕΥΚΟΣ WHITE HOLDER



IP 55



ΗΛΕΚΤΡΙΚΗ ΠΕΤΣΕΤΟΚΡΕΜΑΣΤΡΑ ΑΛΟΥΜΙΝΙΟΥ ΛΕΥΚΗ ALUMINIUM ELECTRIC TOWEL RADIATOR WHITE

ΚΩΔΙΚΟΣ Barcode	Barcode	ΤΙΜΗ	ΜΗΚΟΣ Width/mm	ΥΨΟΣ Height/mm	ΒΑΡΟΣ/ Weight	Watt	ΕΛΕΓΧΟΣ ΘΕΡΜΟΚΡΑΣΙΑΣ Temperature control	ΠΑΡΟΧΗ ΡΕΥΜΑΤΟΣ Power supply
7472	3800154029240	241,04	404	800	3,7	400	5÷85°C	220÷240V 50 Hz
7473	3800154029257	269,86	404	1000	4,6	500	5÷85°C	220÷240V 50 Hz
7474	3800154029264	311,78	558	800	5,6	600	5÷85°C	220÷240V 50 Hz
7475	3800154029271	372,04	558	1000	6,9	750	5÷85°C	220÷240V 50 Hz

ΣΤΕΓΝΩΤΗΡΑΣ ΧΡΩΜΕ CHROME HOLDER



IP 55



THS®
THERMOSTYLE



ΗΛΕΚΤΡΙΚΕΣ ΠΕΤΣΕΤΟΚΡΕΜΑΣΤΡΕΣ ΑΛΟΥΜΙΝΙΟΥ
ALUMINIUM ELECTRIC RADIATORS

THS[®] DESIGN RADIATOR
SOFIA



ΗΛΕΚΤΡΙΚΗ ΠΕΤΣΕΤΟΚΡΕΜΑΣΤΡΑ ΑΛΟΥΜΙΝΙΟΥ ΜΑΥΡΗ
ALUMINIUM ELECTRIC TOWEL RADIATOR BLACK

ΚΩΔΙΚΟΣ Item N	Barcode	ΤΙΜΗ	ΜΗΚΟΣ Width/mm	ΥΨΟΣ Height/mm	ΒΑΡΟΣ/ Weight	Watt	ΕΛΕΓΧΟΣ ΘΕΡΜΟΚΡΑΣΙΑΣ Temperature control	ΠΑΡΟΧΗ ΡΕΥΜΑΤΟΣ Power supply
7480	3800154029325	263,31	404	800	3.7	400	5÷85°C	220-240 V 50 Hz
7481	3800154029332	298,16	404	1000	4.6	500	5÷85°C	220-240 V 50 Hz
7482	3800154029349	342,43	558	800	5.6	600	5÷85°C	220-240 V 50 Hz
7483	3800154029356	413,96	558	1000	6.9	750	5÷85°C	220-240 V 50 Hz

ΣΤΕΓΝΩΤΗΡΑΣ ΧΡΩΜΕ
CHROME HOLDER



IP 55



ΗΛΕΚΤΡΙΚΗ ΠΕΤΣΕΤΟΚΡΕΜΑΣΤΡΑ ΑΛΟΥΜΙΝΙΟΥ ΓΚΡΙ
ALUMINIUM ELECTRIC TOWEL RADIATOR METALIC

ΚΩΔΙΚΟΣ Item N	Barcode	ΤΙΜΗ	ΜΗΚΟΣ Width/mm	ΥΨΟΣ Height/mm	ΒΑΡΟΣ/ Weight	Watt	ΕΛΕΓΧΟΣ ΘΕΡΜΟΚΡΑΣΙΑΣ Temperature control	ΠΑΡΟΧΗ ΡΕΥΜΑΤΟΣ Power supply
7476	3800154029288	262,79	404	800	3.7	400	5÷85°C	220-240 V 50 Hz
7477	3800154029295	298,16	404	1000	4.6	500	5÷85°C	220-240 V 50 Hz
7478	3800154029301	342,43	558	800	5.6	600	5÷85°C	220-240 V 50 Hz
7479	3800154029318	413,96	558	1000	6.9	750	5÷85°C	220-240 V 50 Hz

ΣΤΕΓΝΩΤΗΡΑΣ ΧΡΩΜΕ
CHROME HOLDER



IP 55



ΘΕΡΜΑΝΣΗ HEATING

ΠΕΤΣΕΤΟΚΡΕΜΑΣΤΡΑ ΛΕΥΚΗ ΟΒΑΛ TOWEL RADIATOR FOR BATHROOM OVAL



ΚΩΔΙΚΟΣ Item N	Barcode	ΤΙΜΗ	ΜΗΚΟΣ Width/mm	ΥΨΟΣ Height/mm	ΑΠΟΣΤΑΣΗ ΑΠΟ ΚΕΝΤΡΑ/ Centre distance/mm	ΠΕΡΙΕΚΤΙΚΟΤΗΤΑ ΝΕΡΟΥ Water content/Lt.	Watt/ΔT50°	Watt/ ΔT60°	ΑΡΙΘΜΟΣ ΣΩΛΗΝΩΝ Qty of pipes Ø 22
27899	3800154028922	49,26	400	800	355	2,91	304	374	14
2790	3800154012167	59,68	400	900	355	3,35	334	411	15
27901	3800154028939	53,11	400	1000	355	3,48	360	443	16
2791	3800154012174	66,60	400	1200	355	4,26	442	544	20
2792	3800154012181	106,40	400	1400	355	4,83	498	613	22
279101	3800154032271	78,23	400	1600	355	5,40	505	606	24
2793	3800154012198	65,03	500	800	455	4,90	361	444	14
2794	3800154012204	74,80	500	1200	455	5,54	524	645	20
2795	3800154012211	88,82	500	1400	455	3,80	589	725	22
279102	3800154032288	117,64	500	1600	455	6,17	594	730	24
2796	3800154012228	87,09	600	800	555	4,50	492	606	14
2797	3800154012235	85,86	600	1200	555	5,54	607	747	20

ΠΕΤΣΕΤΟΚΡΕΜΑΣΤΡΑ ΛΕΥΚΗ ΙΣΙΑ TOWEL RADIATOR FOR BATHROOM STRAIGHT



ΚΩΔΙΚΟΣ Item N	Barcode	ΤΙΜΗ	ΜΗΚΟΣ Width/mm	ΥΨΟΣ Height/mm	ΑΠΟΣΤΑΣΗ ΑΠΟ ΚΕΝΤΡΑ/ Centredistance/mm	ΠΕΡΙΕΚΤΙΚΟΤΗΤΑ ΝΕΡΟΥ Water content/Lt.	Watt/ ΔT50°	Watt/ ΔT60°	ΑΡΙΘΜΟΣ ΣΩΛΗΝΩΝ Qty of pipes Ø 22
2725	3800154012044	45,25	400	600	355	2,33	248	305	12
2780	3800154012051	51,54	400	800	355	2,91	304	374	14
27100	3800154012068	51,88	400	900	355	3,35	334	411	15
2741	3800154028892		400	1000	355	3,48	360	443	16
2781	3800154012075	66,89	400	1200	355	4,26	442	544	20
2782	3800154012082	78,78	400	1400	355	4,83	498	613	22
2783	3800154012099	90,21	400	1600	355	5,40	554	682	24
2739	3800154028908	59,21	500	800	455	3,36	361	444	14
27109	3800154028915	78,21	500	1200	455	4,90	524	645	20
27110	3800154032165	85,73	500	1400	455	5,54	589	725	22
27111	3800154032172	94,40	500	1600	455	6,17	653	804	24
27112	3800154032189	84,10	600	1200	555	5,54	607	747	20
27113	3800154032196	96,44	600	1400	555	6,24	679	836	22
27114	3800154032202	104,07	600	1600	555	6,94	752	926	24

ΘΕΡΜΑΝΣΗ HEATING

ΠΕΤΣΕΤΟΚΡΕΜΑΣΤΡΑ ΙΣΙΑ ΧΡΩΜΕ TOWEL RADIATOR FOR BATHROOM STRAIGHT CHROME



ΚΩΔΙΚΟΣ Item N	Barcode	ΤΙΜΗ	ΜΗΚΟΣ Width/mm	ΥΨΟΣ /Height/mm	ΑΠΟΣΤΑΣΗ ΑΠΟ ΚΕΝΤΡΑ/Centre distance/mm	ΠΕΡΙΕΚΤΙΚΟΤΗΤΑ ΝΕΡΟΥ/ Water content/Lt.	Watt/ ΔT50°	Watt/ ΔT60°	ΑΡΙΘΜΟΣ ΣΩΛΗΝΩΝ Qty of pipes Ø22
273001	3800154028946	81,30	400	600	355	2,33	163	201	12
273002	3800154028953	91,70	400	800	355	2,91	201	247	14
273003	3800154023651	106,82	400	1200	355	4,26	292	359	16
273004	3800154028960	147,85	400	1400	355	4,83	329	405	20
273005	3800154032134	146,22	400	1600	355	5,40	366	450	24
273006	3800154028977	110,62	500	800	455	3,36	239	294	14
273008	3800154028984	167,81	500	1200	455	4,90	346	426	20
273009	3800154028991	129,43	500	1400	455	5,54	389	479	22
273010	3800154032141	193,07	500	1600	455	6,17	431	530	24
273011	3800154030437	86,51	600	800	555	3,80	277	341	14
273013	3800154030444	142,95	600	1200	555	5,54	401	494	16
273014	3800154030451	147,72	600	1400	555	6,24	449	553	20
273015	3800154032158	204,49	600	1600	555	6,94	496	610	24

ΠΕΤΣΕΤΟΚΡΕΜΑΣΤΡΑ ΙΣΙΑ ΜΑΥΡΗ TOWEL RADIATOR FOR BATHROOM STRAIGHT BLACK SILKY



Αрт. № Item N	Баркод Barcode	ΤΙΜΗ	Л-Габарит на лирата/Width/mm	Н-Височина на лирата/Height/ mm	Н-Междусие на лирата/Centre distance/mm	Водно съдържание/ Water content/Lt.	Watt/ ΔT50°	Watt/ ΔT60°	Брой тръбички/Qty of pipes Ø22
100073	3800154040856	97,99	400	1200	355	4,26	292	359	16
100074	3800154040863	103,91	500	1200	455	4,90	346	426	20

THS[®]
THERMOSTYLE



ΗΛΕΚΤΡΙΚΕΣ ΑΝΤΙΣΤΑΣΕΙΣ ELECTRIC HEATERS



ΗΛΕΚΤΡΙΚΕΣ ΑΝΤΙΣΤΑΣΕΙΣ ΜΕ ΘΕΡΜΟΣΤΑΤΕΣ ELECTRIC HEATERS WITH THERMOSTAT

ΗΛΕΚΤΡΙΚΗ ΑΝΤΙΣΤΑΣΗ ΜΕ ΘΕΡΜΟΣΤΑΤΗ ΛΕΥΚΗ ΚΕΦΑΛΗ ELECTRIC HEATER WITH THERMOSTAT WHITE HEAD



ΤΥΠΟΣ Type	ΚΩΔΙΚΟΣ Item №	Barcode	Θερμική ισχύς (Watt)	Μήκος σώματος Length of body (cm)	ΤΙΜΗ
THS03W	99081	3800154018497	300	20	100,06
THS06W	99093	3800154018480	600	30	100,16
THS09W	9906	3800154018442	900	40	101,89
THS12W	9915	3800154018473	1200	45,5	105,66
THS15W	9908	3800154018459	1500	48	109,04
THS20W	9907	3800154018466	2000	63	115,15

ΗΛΕΚΤΡΙΚΗ ΑΝΤΙΣΤΑΣΗ ΜΕ ΘΕΡΜΟΣΤΑΤΗ ΧΡΩΜΕ ΚΕΦΑΛΗ ELECTRIC HEATER WITH THERMOSTAT CHROME PLATED HEAD



ΤΥΠΟΣ Type	ΚΩΔΙΚΟΣ Item №	Barcode	Θερμική ισχύς (Watt)	Μήκος σώματος Length of body (cm)	ΤΙΜΗ
THS03CH	99091	3800154018428	300	20	110,09
THS06CH	99092	3800154018435	600	30	99,56
THS09CH	7634	3800154030321	900	40	102,70
THS12CH	7635	3800154030338	1200	45,5	106,90
THS15CH	7636	3800154030345	1500	48	107,42
THS20CH	7637	3800154030352	2000	63	112,14



THS[®]
THERMOSTYLE



ΘΕΡΜΑΝΣΗ HEATING

ΗΛΕΚΤΡΙΚΗ ΑΝΤΙΣΤΑΣΗ ΜΕ ΘΕΡΜΟΣΤΑΤΗ ΜΑΥΡΟ ELECTRIC HEATER WITH THERMOSTAT BLACK HEAD



ΤΥΠΟΣ Type	ΚΩΔΙΚΟΣ Item №	Barcode	Θερμική ισχύς (Watt)	Μήκος σώματος Length of body (cm)	ΤΙΜΗ
THS03BL	7639	3800154030369	300	20	97,46
THS06BL	7640	3800154030376	600	30	99,56
THS09BL	7641	3800154030383	900	40	102,70
THS12BL	7642	3800154030390	1200	45,5	106,90
THS15BL	7643	3800154030406	1500	48	107,42
THS20BL	7644	3800154030413	2000	63	112,14

 **ΑΝΤΙΠΑΓΩΤΙΚΗ ΠΡΟΣΤΑΣΙΑ**
ANTI FROST PROTECTION



Η αντίσταση THS όταν είναι εγκατεστημένη στο θερμαντικό σώμα, πρέπει να συνδέεται σε τάση 220 έως 240V, σε συχνότητα 50 ή 60Hz.

Η σύνδεση γίνεται μέσω πρίζας SHUCO.

Η αντίσταση διαθέτει θερμικό ασφαλείας στους 65°C-75°C.

Ο έλεγχος της θερμοκρασίας γίνεται από 5°C έως 60°C σαν προστασία από υπερθέρμανση ή σε περίπτωση αλλαγής της τάσης του ρεύματος.

ΤΕΧΝΙΚΗ ΧΑΡΑΚΤΗΡΙΣΤΙΚΑ/

TECHNICAL DATA

Μοντέλο Model	THS03	THS06	THS09	THS12	THS15	THS20
Παροχή ρεύματος Electric power supply	220 ÷ 240 V; 50/60 Hz					
Αντιστάσεις Heater power /W/	300	600	900	1200	1500	2000
Έλεγχος θερμοκρασίας Temperature control	5 ÷ 40 ± 3°C					
Καλώδιο 1,5m Connecting cable 1.5 m	ART 105 H05VV-F 3x0.75					
Θερμικό ασφαλείας Melting temperature of the current-responsive element	94°C					
Σπείρωμα συνδέσεως Mechanical connection	G ½"					
IP	44					
Κλίση Insulation class	1					
Βάρος Mass/Weight (g) ±5	455	460	480	505	515	550
Μήκος Length L (mm) ±5	305	355	400	455	480	630

ΕΛΕΚΤΡΙЧЕСΚИ ΗΑΓΡΕΒΑΤΕΛИ С ФИКСИΡΑΗ ΤΕΡΜΟΣΤΑΤ ELECTRIC HEATER WITH FIXED THERMOSTAT

ΗΛΕΚΤΡΙΚΗ ΑΝΤΙΣΤΑΣΗ ΜΕ ΕΝΣΩΜΑΤΩΜΕΝΟ ΘΕΡΜΟΣΤΑΤΗ ΛΕΥΚΗ ELECTRIC HEATER FIXED THERMOSTAT WHITE



ΤΥΠΟΣ Type	ΚΩΔΙΚΟΣ Item №	Barcode	Θερμική ισχύς (Watt)	Μήκος σώματος Length of body (cm)	ΤΙΜΗ
THS03F	99094	3800154019272	300	20	57,38
THS06F	99095	3800154019289	600	30	63,54

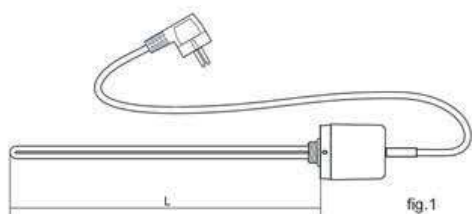

ΤΕΧΝΙΚΗ ΧΑΡΑΚΤΗΡΙΣΤΙΚΑ/

TECHNICAL DATA

Μοντέλο Model	THS03F	THS06F
Παροχή ρεύματος Electric power supply	220 ÷ 240 V; 50/60 Hz	
Αντιστάσεις Heater power /W/	300	600
Έλεγχος θερμοκρασίας Temperature control	5 ÷ 40 ± 3°C	
Καλώδιο 1,5m Connecting cable 1.5 m	H05VV-F 3x0.75	
IP	44	
Κλίση Insulation class	1	
Βάρος Mass/Weight (g) ±5	455	460
Μήκος Length L (mm) ±5	305	355

THS[®]
THERMOSTYLE





ΣΤΗΡΙΓΜΑΤΑ ΓΙΑ ΚΑΛΟΡΙΦΕΡ ΑΛΟΥΜΙΝΙΟΥ ΠΛΑΣΤΙΚΗ ΕΠΙΚΑΛΥΨΗ 2ΤΜΧ HANGERS WITH PLASTIC COVER 2 PCS



ΔΙΑΣΤΑΣΗ Dimension	Αρτ. Νο Item №	Баркод Barcode		ΤΙΜΗ
9 * 170	89932	3800154033148	2/100	1,36
9 * 195	89942	3800154033155	2/100	1,44

ΣΤΗΡΙΓΜΑΤΑ ΓΙΑ ΚΑΛΟΡΙΦΕΡ ΑΛΟΥΜΙΝΙΟΥ 2ΤΜΧ HANGERS FOR ALUMINIUM RADIATOR 2 PCS



ΔΙΑΣΤΑΣΗ Dimension	ΚΩΔΙΚΟΣ Item №	Barcode		ΤΙΜΗ
170 mm	26642	3800154009372	2/500	1,44
195 mm	26722	3800154009389	2/200	1,57
230 mm	26602	3800154015533	2/400	1,89

ΓΩΝΙΑΚΑ ΣΤΗΡΙΓΜΑΤΑ ΓΙΑ ΚΑΛΟΡΙΦΕΡ ΑΛΟΥΜΙΝΙΟΥ ANGEL HANGER FOR ALUMINIUM RADIATOR



ΔΙΑΣΤΑΣΗ Dimension	ΚΩΔΙΚΟΣ Item №	Barcode		ΤΙΜΗ
	2663	3800154009396	1/300	1,15

ΣΤΗΡΙΓΜΑΤΑ ΔΑΠΕΔΟΥ ΓΙΑ ΚΑΛΟΡΙΦΕΡ ΑΛΟΥΜΙΝΙΟΥ FLOOR HANGER FOR ALUMINIUM RADIATOR



ΔΙΑΣΤΑΣΗ Dimension	ΚΩΔΙΚΟΣ Item №	Barcode		ΤΙΜΗ
H 290 mm	2662	3800154009402	1/50	10,53
H 390 mm	2656	3800154026225	1/50	11,74

ΣΤΗΡΙΓΜΑΤΑ ΓΙΑ ΚΑΛΟΡΙΦΕΡ ΤΥΠΟΥ ΠΑΝΕΛ FLOOR HANGER FOR PANEL RADIATOR



ΔΙΑΣΤΑΣΗ Dimension	ΚΩΔΙΚΟΣ Item №	Barcode		ΤΙΜΗ
H 300 mm	2655	3800154009419	1/50	10,53

ΣΤΗΡΙΓΜΑΤΑ ΠΕΤΣΕΤΟΚΡΕΜΑΣΤΡΑΣ HANGER FOR TOWEL - 3 PCS IN A SET



ΔΙΑΣΤΑΣΗ Dimension	ΚΩΔΙΚΟΣ Item №	Barcode		ΤΙΜΗ
	2738	3800154026942	1/50	9,38

ΘΕΡΜΑΝΣΗ HEATING

ΤΑΠΑ ΓΙΑ ΚΑΛΟΡΙΦΕΡ ΑΛΟΥΜΙΝΙΟΥ END CAP FOR ALUMINIUM RADIATOR



ΔΙΑΣΤΑΣΗ Dimension	ΚΩΔΙΚΟΣ Item №	Barcode		ΤΙΜΗ
ΔΕΞΙ/RIGHT	2435	3800154009440		0,76
ΑΡΙΣΤΕΡΟ/LEFT	2436	3800154009457		0,76

ΤΕΡΜΑΤΙΚΟ ΓΙΑ ΚΑΛΟΡΙΦΕΡ ΑΛΟΥΜΙΝΙΟΥ END REDUCER FOR ALUMINIUM RADIATOR



ΔΙΑΣΤΑΣΗ Dimension	ΚΩΔΙΚΟΣ Item №	Barcode		ΤΙΜΗ
1" * 1/2" ΔΕΞΙ/ RIGHT	2437	3800154009464		0,71
1" * 1/2" ΑΡΙΣΤΕΡΟ/ LEFT	2438	3800154009471		0,71

ΣΕΤ ΚΑΛΟΡΙΦΕΡ 7ΤΜΧ SET 7 IN 1 FOR ALUMINIUM RADIATOR



ΔΙΑΣΤΑΣΗ Dimension	ΚΩΔΙΚΟΣ Item №	Barcode		ΤΙΜΗ
1 * 1/2"	2440	3800154009426		3,35

ΣΕΤ ΚΑΛΟΡΙΦΕΡ ΑΛΟΥΜΙΝΙΟΥ ΜΕ ΔΥΟ ΣΤΗΡΙΓΜΑΤΑ 11ΤΜΧ SET 11 IN 1 FOR ALUMINIUM RADIATOR 2 HANGERS INCLUDED



ΔΙΑΣΤΑΣΗ Dimension	ΚΩΔΙΚΟΣ Item №	Barcode		ΤΙΜΗ
170 mm 1 * 1/2"	2017	3800154009433		4,11

ΝΙΠΕΛ ΓΙΑ ΚΑΛΟΡΙΦΕΡ ΑΛΟΥΜΙΝΙΟΥ NIPPEL CONNECTOR FOR ALUMINIUM RADIATOR



ΔΙΑΣΤΑΣΗ Dimension	ΚΩΔΙΚΟΣ Item №	Barcode		ΤΙΜΗ
1"	2442	3800154009365		0,31

ΣΕΤ ΚΑΛΟΡΙΦΕΡ ΑΛΟΥΜΙΝΙΟΥ ΜΕ ΤΡΙΑ ΣΤΗΡΙΓΜΑΤΑ 13ΤΜΧ SET 13 IN 1 FOR ALUMINIUM RADIATOR 3 HANGERS INCLUDED



ΔΙΑΣΤΑΣΗ Dimension	ΚΩΔΙΚΟΣ Item №	Barcode		ΤΙΜΗ
170 mm 1 * 1/2"	8290	3800154031588		4,51



ΕΞΑΕΡΙΣΤΙΚΟ
MANUAL AIR VENT



ΔΙΑΣΤΑΣΗ Dimension	ΚΩΔΙΚΟΣ Item №	Barcode		ΤΙΜΗ
1/2"	2416	3800154009303	10/1000	0,89
1/2"	9894	3800154040320	100/1000	1,02

ΚΛΕΙΔΙ ΕΞΑΕΡΙΣΜΟΥ
METAL KEY FOR MANUAL AIR VENT



ΔΙΑΣΤΑΣΗ Dimension	ΚΩΔΙΚΟΣ Item №	Barcode		ΤΙΜΗ
5 mm * 5 mm	24162	3800154016998	1/3000	0,47
5 mm * 5 mm	2416200	3800154040313	100/3000	0,29

ΑΥΤΟΜΑΤΟ ΕΞΑΕΡΙΣΤΙΚΟ ΙΣΙΟ ΧΡΩΜΕ
AUTOMATIC AIR VENT STRAIGHT BRASS NICKEL PLATED
ECONOMIC



ΔΙΑΣΤΑΣΗ Dimension	ΚΩΔΙΚΟΣ Item №	Barcode		ΤΙΜΗ
1/2"	2400	3800154022357	1/100	5,50

ΑΥΤΟΜΑΤΟ ΕΞΑΕΡΙΣΤΙΚΟ ΓΩΝΙΑΚΟ ΧΡΩΜΕ
ECONOMIC
AUTOMATIC AIR VENT ANGLE BRASS NICKEL PLATED
ECONOMIC



ΔΙΑΣΤΑΣΗ Dimension	ΚΩΔΙΚΟΣ Item №	Barcode		ΤΙΜΗ
1/2"	2401	3800154022364	1/100	5,90

ΑΥΤΟΜΑΤΟ ΕΞΑΕΡΙΣΤΙΚΟ ΙΣΙΟ ΟΡΕΙΧΑΛΚΙΝΟ-ΧΡΩΜΕ
AUTOMATIC AIR VENT STRAIGHT BRASS NICKEL PLATED



ΔΙΑΣΤΑΣΗ Dimension	ΚΩΔΙΚΟΣ Item №	Barcode		ΤΙΜΗ
1/2"	2417	3800154009310	1/100	5,82

ΑΥΤΟΜΑΤΟ ΕΞΑΕΡΙΣΤΙΚΟ ΓΩΝΙΑΚΟ ΧΡΩΜΕ
AUTOMATIC AIR VENT ANGLE BRASS NICKEL PLATED



ΔΙΑΣΤΑΣΗ Dimension	ΚΩΔΙΚΟΣ Item №	Barcode		ΤΙΜΗ
1/2"	2421	3800154009327	1/100	6,42

ΑΥΤΟΜΑΤΟ ΕΞΑΕΡΙΣΤΙΚΟ ΔΙΚΤΥΟΥ
AUTOMATIC AIR VENT STRAIGHT BRASS



ΔΙΑΣΤΑΣΗ Dimension	ΚΩΔΙΚΟΣ Item №	Barcode		ΤΙΜΗ
1/2"	6762	3800154028236		5,61

ΑΥΤΟΜΑΤΟ ΕΞΑΕΡΙΣΤΙΚΟ ΔΙΚΤΥΟΥ ΜΕ ΒΑΛΒΙΔΑ ΑΝΤΕΠΙΣΤΡΟΦΗΣ
AUTOMATIC AIR VENT STRAIGHT WITH CHECK VALVE BRASS CHROME PLATED



ΔΙΑΣΤΑΣΗ Dimension	ΚΩΔΙΚΟΣ Item №	Barcode		ΤΙΜΗ
1/2"	5911	3800154022296		7,23

ΑΥΤΟΜΑΤΟ ΕΞΑΕΡΙΣΤΙΚΟ ΔΙΚΤΥΟΥ
AUTOMATIC AIR VENT STRAIGHT BRASS NICKEL PLATED



ΔΙΑΣΤΑΣΗ Dimension	ΚΩΔΙΚΟΣ Item №	Barcode		ΤΙΜΗ
ΑΡΙΣΤΕΡΟ / LEFT	2418	3800154009334		6,68
ΔΕΞΙ / RIGHT	2420	3800154009341		6,68

ΑΥΤΟΜΑΤΟ ΕΞΑΕΡΙΣΤΙΚΟ ΔΙΚΤΥΟΥ SOLAR
AUTOMATIC AIR VENT STRAIGHT BRASS NICKEL PLATED SOLAR

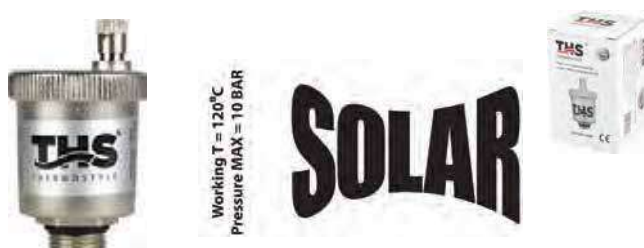

ΔΙΑΣΤΑΣΗ Dimension	ΚΩΔΙΚΟΣ Item №	Barcode		ΤΙΜΗ
1/2"	24244	3800154023217		10,87

ΑΥΤΟΜΑΤΟ ΕΞΑΕΡΙΣΤΙΚΟ ΔΙΚΤΥΟΥ
AUTOMATIC AIR VENT STRAIGHT BLACK



ΔΙΑΣΤΑΣΗ Dimension	ΚΩΔΙΚΟΣ Item №	Barcode		ΤΙΜΗ
1/2"	7751	3800154031427		6,16

ΑΥΤΟΜΑΤΟ ΕΞΑΕΡΙΣΤΙΚΟ ΔΙΚΤΥΟΥ ΜΕ ΒΑΛΒΙΔΑ ΑΝΤΕΠΙΣΤΡΟΦΗΣ
BRASS AUTOMATIC AIR VENT STRAIGHT WHITE CHECK VALVE



ΔΙΑΣΤΑΣΗ Dimension	ΚΩΔΙΚΟΣ Item №	Barcode		ΤΙΜΗ
1/2"	7752	3800154031434		5,34

ΑΥΤΟΜΑΤΟ ΕΞΑΕΡΙΣΤΙΚΟ ΒΑΛΒΙΔΑ 1/2"

AIRVENT 1/2"



ΔΙΑΣΤΑΣΗ Dimension	ΚΩΔΙΚΟΣ Item №	Barcode		ΤΙΜΗ
1/2"	8301	3800154031779	10/1000	4,14
1/2"	8300	3800154031779	10/1000	3,22

ΒΑΛΒΙΔΑ ΑΥΤΟΜΑΤΟΥ ΕΞΑΕΡΙΣΤΙΚΟΥ

BRASS CHROME PATED CHECK VALVE FOR AIRVENT



Размер Dimension	Αрт. № Item №	Баркод Barcode		ΤΙΜΗ
1/2"	24192			2,12

ΣΕΤ ΚΑΛΟΡΙΦΕΡ ΓΩΝΙΑΚΟ 3ΣΕ1

RADIATOR VALVE SET - ANGLE 3 in 1

ΓΩΝΙΑΚΟ



ΔΙΑΣΤΑΣΗ Dimension	ΚΩΔΙΚΟΣ Item №	Barcode		ΤΙΜΗ
1/2"	6183	3800154023590	1/40	23,45



Το σετ περιλαμβάνει:

- Γωνιακό διακόπτη θερμοκεφαλής 1/2"
- Γωνιακό διακόπτη ασφαλείας 1/2"
- Θερμοστατική κεφαλή - M30 x 1,5

The set includes:

- **Angle radiator valve for thermostatic head 1/2"**;
- **Angle safety radiator valve 1/2"**;
- Thermostatic head - M30 X 1.5;

ΣΕΤ ΚΑΛΟΡΙΦΕΡ ΙΣΙΟ 3ΣΕ1

RADIATOR VALVE SET - STRAIGHT 3 in 1

ΙΣΙΟ



ΔΙΑΣΤΑΣΗ Dimension	ΚΩΔΙΚΟΣ Item №	Barcode		ΤΙΜΗ
1/2"	6891	3800154029066	1/40	20,83



Το σετ περιλαμβάνει:

- Ισιο διακόπτη θερμοκεφαλής 1/2"
- Ισιο διακόπτη ασφαλείας 1/2"
- Θερμοστατική κεφαλή - M30 x 1,5

The set includes:

- **Straight radiator valve for thermostatic head 1/2"**;
- **Straight safety radiator valve 1/2"**;
- Thermostatic head - M30 X 1.5;





ΣΕΤ ΚΑΛΟΡΙΦΕΡ LUX DUO ΜΑΥΡΟ ΙΣΙΟ
RADIATOR SET LUX DUO BLACK STRAIGHT



ΔΙΑΣΤΑΣΗ Dimension	ΚΩΔΙΚΟΣ Item N°	Barcode		ΤΙΜΗ
1/2"	7603	3800154030062	1/20	22,06

ΣΕΤ ΚΑΛΟΡΙΦΕΡ LUX DUO ΜΑΥΡΟ ΓΩΝΙΑΚΟ
RADIATOR SET LUX DUO BLACK ANGLE



ΔΙΑΣΤΑΣΗ Dimension	ΚΩΔΙΚΟΣ Item N°	Barcode		ΤΙΜΗ
1/2"	7600	3800154030031	1/20	21,09

ΣΕΤ ΚΑΛΟΡΙΦΕΡ LUX DUO ΛΕΥΚΟ ΙΣΙΟ
RADIATOR SET LUX DUO WHITE STRAIGHT



ΔΙΑΣΤΑΣΗ Dimension	ΚΩΔΙΚΟΣ Item N°	Barcode		ΤΙΜΗ
1/2"	7604	3800154030079	1/20	20,59

ΣΕΤ ΚΑΛΟΡΙΦΕΡ LUX DUO ΛΕΥΚΟ ΓΩΝΙΑΚΟ
RADIATOR SET LUX DUO WHITE ANGLE



ΔΙΑΣΤΑΣΗ Dimension	ΚΩΔΙΚΟΣ Item N°	Barcode		ΤΙΜΗ
1/2"	7601	3800154030048	1/20	19,60

ΣΕΤ ΚΑΛΟΡΙΦΕΡ LUX DUO ΧΡΩΜΕ ΙΣΙΟ
RADIATOR SET LUX DUO CHROME STRAIGHT



ΔΙΑΣΤΑΣΗ Dimension	ΚΩΔΙΚΟΣ Item N°	Barcode		ΤΙΜΗ
1/2"	7605	3800154030086	1/20	20,59

ΣΕΤ ΚΑΛΟΡΙΦΕΡ LUX DUO ΧΡΩΜΕ ΓΩΝΙΑΚΟ
RADIATOR SET LUX DUO CHROME ANGLE



ΔΙΑΣΤΑΣΗ Dimension	ΚΩΔΙΚΟΣ Item N°	Barcode		ΤΙΜΗ
1/2"	7602	3800154030055	1/20	19,55



ΘΕΡΜΑΝΣΗ HEATING

ΣΕΤ ΚΑΛΟΡΙΦΕΡ LUX DUO ΜΑΥΡΟ ΙΣΙΟ
RADIATOR SET LUX DUO BLACK STRAIGHT





ΔΙΑΣΤΑΣΗ Dimension	ΚΩΔΙΚΟΣ Item №	Barcode		ΤΙΜΗ
1/2" x 16 mm	7609	3800154030123	1/20	25,05

ΔΙΑΣΤΑΣΗ Dimension	ΚΩΔΙΚΟΣ Item №	Barcode		ΤΙΜΗ
1/2" x 16 mm	7606	3800154030093	1/20	23,97

ΣΕΤ ΚΑΛΟΡΙΦΕΡ LUX DUO ΛΕΥΚΟ ΙΣΙΟ
RADIATOR SET LUX DUO WHITE STRAIGHT



ΔΙΑΣΤΑΣΗ Dimension	ΚΩΔΙΚΟΣ Item №	Barcode		ΤΙΜΗ
1/2" x 16 mm	7610	3800154030130	1/20	23,58

ΔΙΑΣΤΑΣΗ Dimension	ΚΩΔΙΚΟΣ Item №	Barcode		ΤΙΜΗ
1/2" x 16 mm	7607	3800154030109	1/20	22,56

ΣΕΤ ΚΑΛΟΡΙΦΕΡ LUX DUO ΧΡΩΜΕ ΙΣΙΟ
RADIATOR SET LUX DUO CHROME STRAIGHT



ΔΙΑΣΤΑΣΗ Dimension	ΚΩΔΙΚΟΣ Item №	Barcode		ΤΙΜΗ
1/2" x 16 mm	7611	3800154030147	1/20	23,58

ΔΙΑΣΤΑΣΗ Dimension	ΚΩΔΙΚΟΣ Item №	Barcode		ΤΙΜΗ
1/2" x 16 mm	7608	3800154030116	1/20	22,56



ΣΕΤ ΚΑΛΟΡΙΦΕΡ CAYMAN 3ΣΕ1 ΙΣΙΟ
RADIATOR SET CAYMAN 3 IN 1 BLACK STRAIGHT



ΣΕΤ ΚΑΛΟΡΙΦΕΡ CAYMAN 3ΣΕ1 ΓΩΝΙΑΚΟ
RADIATOR SET CAYMAN 3 IN 1 BLACK ANGLE



ΔΙΑΣΤΑΣΗ Dimension	ΚΩΔΙΚΟΣ Item №	Barcode		ΤΙΜΗ
1/2"	7577	3800154029806	1/20	27,56

ΔΙΑΣΤΑΣΗ Dimension	ΚΩΔΙΚΟΣ Item №	Barcode		ΤΙΜΗ
1/2"	7576	3800154029790	1/20	26,83

ΣΕΤ ΚΑΛΟΡΙΦΕΡ CAYMAN 3ΣΕ1 ΛΕΥΚΟ ΙΣΙΟ
RADIATOR SET CAYMAN 3 IN 1 WHITE STRAIGHT



ΣΕΤ ΚΑΛΟΡΙΦΕΡ CAYMAN 3ΣΕ1 ΛΕΥΚΟ ΓΩΝΙΑΚΟ
RADIATOR SET CAYMAN 3 IN 1 WHITE ANGLE



ΔΙΑΣΤΑΣΗ Dimension	ΚΩΔΙΚΟΣ Item №	Barcode		ΤΙΜΗ
1/2"	7579	3800154029868	1/20	25,39

ΔΙΑΣΤΑΣΗ Dimension	ΚΩΔΙΚΟΣ Item №	Barcode		ΤΙΜΗ
1/2"	7578	3800154029851	1/20	24,63

ΣΕΤ ΚΑΛΟΡΙΦΕΡ CAYMAN 3ΣΕ1 ΧΡΩΜΕ ΙΣΙΟ
RADIATOR SET CAYMAN 3 IN 1 CHROME STRAIGHT



ΣΕΤ ΚΑΛΟΡΙΦΕΡ CAYMAN 3ΣΕ1 ΧΡΩΜΕ ΓΩΝΙΑΚΟ
RADIATOR SET CAYMAN 3 IN 1 CHROME ANGLE



ΔΙΑΣΤΑΣΗ Dimension	ΚΩΔΙΚΟΣ Item №	Barcode		ΤΙΜΗ
1/2"	7581	3800154029882	1/20	25,13

ΔΙΑΣΤΑΣΗ Dimension	ΚΩΔΙΚΟΣ Item №	Barcode		ΤΙΜΗ
1/2"	7580	3800154029875	1/20	24,92

Κάθε σετ περιλαμβάνει:

1. Θερμοστατική κεφαλή M30 x 1.5
2. Βάνα 1/2" ίσια
3. Θερμοβάνο 1/2" ασφαλείας ίσια
4. Αντάπτορα με παξιμάδια για σωλήνα PEX-AL-PEX Ø16MM – 2ΤΜΧ
5. Παξιμάδια με O-RING για ορειχάλκινο σωλήνα Ø15MM – 2ΤΜΧ

Each set includes:

1. THERMOSTATIC HEAD M30 x 1.5
2. STRAIGHT THERMOSTATIC RADIATOR VALVE
3. STRAIGHT SAFETY RADIATOR VALVE
4. FITTINGS WITH NUTS FOR PEX-AL-PEX Ø16MM – 2 PCS
5. NUTS WITH RINGS FOR COPPER PIPE Ø15MM – 2 PCS

ΣΕΤ ΚΑΛΟΡΙΦΕΡ CAYMAN 7ΣΕ1 ΜΑΥΡΟ ΙΣΙΟ RADIATOR SET CAYMAN 7 IN 1 BLACK STRAIGHT



ΠΕΡΙΛΑΜΒΑΝΟΝΤΑΙ
ΡΑΚΟΡ Pex-Al-Pex Ø16 mm - 2 ΤΜΧ.
ΡΑΚΟΡ ΧΑΛΚΟΥ Ø15 mm - 2 ΤΜΧ.

Fittings with nuts for Pex-Al-Pex Ø16mm – 2 pcs
Nuts with rings for copper pipe Ø15mm - 2 pcs
INCLUDED IN THE SET



ΕΠΙΛΟΓΗ Νο1/ OPTION Νο1

ΡΑΚΟΡ Pex-Al-Pex Ø16 mm - 2 ΤΜΧ.
Fittings with nuts for Pex-Al-Pex
Ø16mm – 2 pcs

ΕΠΙΛΟΓΗ Νο2/ OPTION Νο2

ΡΑΚΟΡ ΧΑΛΚΟΥ Ø15 mm - 2 ΤΜΧ.
Nuts with rings for copper pipe
Ø15mm- 2 pcs

ΔΙΑΣΤΑΣΗ Dimension	ΚΩΔΙΚΟΣ Item №	Barcode		ΤΙΜΗ
1/2" x 16mm + 1/2" x 15mm	7583	3800154029820	1/20	32,10

ΣΕΤ ΚΑΛΟΡΙΦΕΡ CAYMAN 7ΣΕ1 ΛΕΥΚΟ ΙΣΙΟ RADIATOR SET CAYMAN 7 IN 1 WHITE STRAIGHT

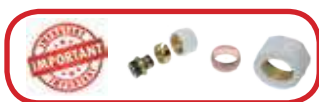

ΠΕΡΙΛΑΜΒΑΝΟΝΤΑΙ
ΡΑΚΟΡ Pex-Al-Pex Ø16 mm - 2 ΤΜΧ.
ΡΑΚΟΡ ΧΑΛΚΟΥ Ø15 mm - 2 ΤΜΧ.

Fittings with nuts for Pex-Al-Pex Ø16mm – 2 pcs
Nuts with rings for copper pipe Ø15mm - 2 pcs
INCLUDED IN THE SET



ΕΠΙΛΟΓΗ Νο1/ OPTION Νο1

ΡΑΚΟΡ Pex-Al-Pex Ø16 mm - 2 ΤΜΧ.
Fittings with nuts for Pex-Al-Pex
Ø16mm – 2 pcs

ΕΠΙΛΟΓΗ Νο2/ OPTION Νο2

ΡΑΚΟΡ ΧΑΛΚΟΥ Ø15 mm - 2 ΤΜΧ.
Nuts with rings for copper pipe
Ø15mm- 2 pcs

ΔΙΑΣΤΑΣΗ Dimension	ΚΩΔΙΚΟΣ Item №	Barcode		ΤΙΜΗ
1/2" x 16mm + 1/2" x 15mm	7585	3800154029905	1/20	29,19

ΣΕΤ ΚΑΛΟΡΙΦΕΡ CAYMAN 7ΣΕ1 ΧΡΩΜΕ ΙΣΙΟ RADIATOR SET CAYMAN 7 IN 1 CHROME STRAIGHT



ΠΕΡΙΛΑΜΒΑΝΟΝΤΑΙ
ΡΑΚΟΡ Pex-Al-Pex Ø16 mm - 2 ΤΜΧ.
ΡΑΚΟΡ ΧΑΛΚΟΥ Ø15 mm - 2 ΤΜΧ.

Fittings with nuts for Pex-Al-Pex Ø16mm – 2 pcs
Nuts with rings for copper pipe Ø15mm - 2 pcs
INCLUDED IN THE SET



ΕΠΙΛΟΓΗ Νο1/ OPTION Νο1

ΡΑΚΟΡ Pex-Al-Pex Ø16 mm - 2 ΤΜΧ.
Fittings with nuts for Pex-Al-Pex
Ø16mm – 2 pcs

ΕΠΙΛΟΓΗ Νο2/ OPTION Νο2

ΡΑΚΟΡ ΧΑΛΚΟΥ Ø15 mm - 2 ΤΜΧ.
Nuts with rings for copper pipe
Ø15mm- 2 pcs

ΔΙΑΣΤΑΣΗ Dimension	ΚΩΔΙΚΟΣ Item №	Barcode		ΤΙΜΗ
1/2" x 16mm + 1/2" x 15mm	7587	3800154029929	1/20	30,10

Κάθε σετ περιλαμβάνει:

1. Θερμοστατική κεφαλή M30 x 1,5
2. Βάνα 1/2" γωνιακή
3. Βάνα ασφαλείας 1/2" για καλοριφέρ
4. Αντάπτορα με παξιμάδια για σωλήνα PEX-AL-PEX Ø16MM – 2TMX
5. Παξιμάδια με O-RING για ορειχάλκινο σωλήνα Ø15MM – 2TMX

Each set includes:

1. THERMOSTATIC HEAD M30 x 1.5
2. ANGLE THERMOSTATIC RADIATOR VALVE
3. ANGLE SAFETY RADIATOR VALVE
4. FITTINGS WITH NUTS FOR PEX-AL-PEX Ø16MM – 2 PCS
5. NUTS WITH RINGS FOR COPPER PIPE Ø15MM – 2 PCS

ΣΕΤ ΚΑΛΟΡΙΦΕΡ CAYMAN 7ΣΕ1 ΜΑΥΡΟ ΓΩΝΙΑΚΟ RADIATOR SET CAYMAN 7 IN 1 BLACK ANGLE



ΠΕΡΙΛΑΜΒΑΝΟΝΤΑΙ
ΡΑΚΟΡ Pex-Al-Pex Ø16 mm - 2 TMX.
ΡΑΚΟΡ ΧΑΛΚΟΥ Ø15 mm - 2 TMX.
Fittings with nuts for Pex-Al-Pex Ø16mm – 2 pcs
Nuts with rings for copper pipe Ø15mm - 2 pcs
INCLUDED IN THE SET

BLISTER



ΕΠΙΛΟΓΗ №1/ OPTION №1

ΡΑΚΟΡ Pex-Al-Pex Ø16 mm - 2 TMX.
Fittings with nuts for Pex-Al-Pex
Ø16mm – 2 pcs

ΕΠΙΛΟΓΗ №2/ OPTION №2

ΡΑΚΟΡ ΧΑΛΚΟΥ Ø15 mm - 2 TMX.
Nuts with rings for copper pipe
Ø15mm – 2 pcs

ΔΙΑΣΤΑΣΗ Dimension	ΚΩΔΙΚΟΣ Item №	Barcode		ΤΙΜΗ
1/2" x 16mm + 1/2" x 15mm	7582	3800154029813	1/20	31,34

ΣΕΤ ΚΑΛΟΡΙΦΕΡ CAYMAN 7ΣΕ1 ΛΕΥΚΟ ΓΩΝΙΑΚΟ RADIATOR SET CAYMAN 7 IN 1 WHITE ANGLE



ΠΕΡΙΛΑΜΒΑΝΟΝΤΑΙ
ΡΑΚΟΡ Pex-Al-Pex Ø16 mm - 2 TMX.
ΡΑΚΟΡ ΧΑΛΚΟΥ Ø15 mm - 2 TMX.
Fittings with nuts for Pex-Al-Pex Ø16mm – 2 pcs
Nuts with rings for copper pipe Ø15mm - 2 pcs
INCLUDED IN THE SET

BLISTER



ΕΠΙΛΟΓΗ №1/ OPTION №1

ΡΑΚΟΡ Pex-Al-Pex Ø16 mm - 2 TMX.
Fittings with nuts for Pex-Al-Pex
Ø16mm – 2 pcs

ΕΠΙΛΟΓΗ №2/ OPTION №2

ΡΑΚΟΡ ΧΑΛΚΟΥ Ø15 mm - 2 TMX.
Nuts with rings for copper pipe
Ø15mm - 2 pcs

ΔΙΑΣΤΑΣΗ Dimension	ΚΩΔΙΚΟΣ Item №	Barcode		ΤΙΜΗ
1/2" x 16mm + 1/2" x 15mm	7584	3800154029899	1/20	29,34

ΣΕΤ ΚΑΛΟΡΙΦΕΡ CAYMAN 7ΣΕ1 ΧΡΩΜΕ ΓΩΝΙΑΚΟ RADIATOR SET CAYMAN 7 IN 1 CHROME ANGLE



ΠΕΡΙΛΑΜΒΑΝΟΝΤΑΙ
ΡΑΚΟΡ Pex-Al-Pex Ø16 mm - 2 TMX.
ΡΑΚΟΡ ΧΑΛΚΟΥ Ø15 mm - 2 TMX.
Fittings with nuts for Pex-Al-Pex Ø16mm – 2 pcs
Nuts with rings for copper pipe Ø15mm - 2 pcs
INCLUDED IN THE SET

BLISTER



ΕΠΙΛΟΓΗ №1/ OPTION №1

ΡΑΚΟΡ Pex-Al-Pex Ø16 mm - 2 TMX.
Fittings with nuts for Pex-Al-Pex
Ø16mm – 2 pcs

ΕΠΙΛΟΓΗ №2/ OPTION №2

ΡΑΚΟΡ ΧΑΛΚΟΥ Ø15 mm - 2 TMX.
Nuts with rings for copper pipe
Ø15mm - 2 pcs

ΔΙΑΣΤΑΣΗ Dimension	ΚΩΔΙΚΟΣ Item №	Barcode		ΤΙΜΗ
1/2" x 16mm + 1/2" x 15mm	7586	3800154029912	1/20	29,66

THS
THERMOSTYLE



Κάθε σετ περιλαμβάνει:

1. Θερμοστατική κεφαλή M30 x 1,5
2. Διπλή γωνιακή βάνα 1/2" για καλοριφέρ
3. Διπλή βάνα ασφαλείας 1/2" για καλοριφέρ
4. Αντάπτορα με παξιμάδια για σωλήνα PEX-AL-PEX Ø16MM – 2TMX
5. Παξιμάδια με O-RING για ορειχάλκινο σωλήνα Ø15MM – 2TMX

Each set includes:

1. THERMOSTATIC HEAD M30 x 1,5
2. DOUBLE ANGLE THERMOSTATIC RADIATOR VALVE
3. DOUBLE ANGLE SAFETY RADIATOR VALVE
4. FITTINGS WITH NUTS FOR PEX-AL-PEX Ø16MM – 2 PCS
5. NUTS WITH RINGS FOR COPPER PIPE Ø15MM – 2 PCS

ΔΙΠΛΟ ΓΩΝΙΑΚΟ ΣΕΤ ΠΕΤΣΕΤΟΚΡΕΜΑΣΤΡΑΣ CAYMAN ΜΑΥΡΟ DOUBLE ANGEL SET FOR TOWEL CAYMAN BLACK



ΠΕΡΙΛΑΜΒΑΝΟΝΤΑΙ
ΠΑΚΟΡ Pex-Al-Pex Ø16 mm - 2 TMX,
ΠΑΚΟΡ ΧΑΛΚΟΥ Ø15 mm - 2 TMX,
Fittings with nuts for Pex-Al-Pex Ø16mm – 2 pcs
Nuts with rings for copper pipe Ø15mm - 2 pcs
INCLUDED IN THE SET



ΕΠΙΛΟΓΗ Νº1/ OPTION Nº1

ΠΑΚΟΡ Pex-Al-Pex Ø16 mm - 2 TMX,
Fittings with nuts for Pex-Al-Pex
Ø16mm - 2 pcs



ΕΠΙΛΟΓΗ Νº2/ OPTION Nº2

ΠΑΚΟΡ ΧΑΛΚΟΥ Ø15 mm - 2 TMX,
Nuts with rings for copper pipe
Ø15mm - 2 pcs



ΔΙΑΣΤΑΣΗ Dimension	ΚΩΔΙΚΟΣ Item N°	Barcode		ΤΙΜΗ
1/2" x 16mm + 1/2" x 15mm	7613	3800154030161	1/20	58,90

ΔΙΠΛΟ ΓΩΝΙΑΚΟ ΣΕΤ ΠΕΤΣΕΤΟΚΡΕΜΑΣΤΡΑΣ CAYMAN ΛΕΥΚΟ DOUBLE ANGEL SET FOR TOWEL CAYMAN WHITE



ΠΕΡΙΛΑΜΒΑΝΟΝΤΑΙ
ΠΑΚΟΡ Pex-Al-Pex Ø16 mm - 2 TMX,
ΠΑΚΟΡ ΧΑΛΚΟΥ Ø15 mm - 2 TMX,
Fittings with nuts for Pex-Al-Pex Ø16mm – 2 pcs
Nuts with rings for copper pipe Ø15mm - 2 pcs
INCLUDED IN THE SET



ΕΠΙΛΟΓΗ Νº1/ OPTION Nº1

ΠΑΚΟΡ Pex-Al-Pex Ø16 mm - 2 TMX,
Fittings with nuts for Pex-Al-Pex
Ø16mm - 2 pcs



ΕΠΙΛΟΓΗ Νº2/ OPTION Nº2

ΠΑΚΟΡ ΧΑΛΚΟΥ Ø15 mm - 2 TMX,
Nuts with rings for copper pipe
Ø15mm - 2 pcs



ΔΙΑΣΤΑΣΗ Dimension	ΚΩΔΙΚΟΣ Item N°	Barcode		ΤΙΜΗ
1/2" x 16mm + 1/2" x 15mm	7614	3800154030178	1/20	52,35

ΔΙΠΛΟ ΓΩΝΙΑΚΟ ΣΕΤ ΠΕΤΣΕΤΟΚΡΕΜΑΣΤΡΑΣ CAYMAN ΧΡΩΜΕ DOUBLE ANGEL SET FOR TOWEL CAYMAN CHROME



ΠΕΡΙΛΑΜΒΑΝΟΝΤΑΙ
ΠΑΚΟΡ Pex-Al-Pex Ø16 mm - 2 TMX,
ΠΑΚΟΡ ΧΑΛΚΟΥ Ø15 mm - 2 TMX,
Fittings with nuts for Pex-Al-Pex Ø16mm – 2 pcs
Nuts with rings for copper pipe Ø15mm - 2 pcs
INCLUDED IN THE SET



ΕΠΙΛΟΓΗ Νº1/ OPTION Nº1

ΠΑΚΟΡ Pex-Al-Pex Ø16 mm - 2 TMX,
Fittings with nuts for Pex-Al-Pex
Ø16mm - 2 pcs



ΕΠΙΛΟΓΗ Νº2/ OPTION Nº2

ΠΑΚΟΡ ΧΑΛΚΟΥ Ø15 mm - 2 TMX,
Nuts with rings for copper pipe
Ø15mm - 2 pcs



ΔΙΑΣΤΑΣΗ Dimension	ΚΩΔΙΚΟΣ Item N°	Barcode		ΤΙΜΗ
1/2" x 16mm + 1/2" x 15mm	7612	3800154030154	1/20	52,35

THS[®]
THERMOSTYLE





ΘΕΡΜΑΝΣΗ HEATING

ΔΙΑΚΟΠΤΗΣ ΚΑΛΟΡΙΦΕΡ ΙΣΙΟΣ ΓΙΑ ΘΕΡΜΟΣΤΑΤΙΚΗ ΚΕΦΑΛΗ
ΟΡΕΙΧΑΛΚΙΝΗ ΕΠΙΝΙΚΕΛΩΜΕΝΗ
RADIATOR VALVE FOR THERMOSTATIC HEAD STRAIGHT BRASS
NICKEL PLATED



ΔΙΑΣΤΑΣΗ Dimension	ΚΩΔΙΚΟΣ Item №	Barcode		ΤΙΜΗ
M30 x 1.5 1/2"	24009	3800154009709	1/100	8,23

ΔΙΑΚΟΠΤΗΣ ΚΑΛΟΡΙΦΕΡ ΙΣΙΟΣ ΓΙΑ ΘΕΡΜΟΣΤΑΤΙΚΗ ΚΕΦΑΛΗ ΕΠΙΧΡΩΜΗ
RADIATOR VALVE FOR THERMOSTATIC HEAD STRAIGHT BRASS
CHROME PLATED



ΔΙΑΣΤΑΣΗ Dimension	ΚΩΔΙΚΟΣ Item №	Barcode		ΤΙΜΗ
M30 x 1.5 1/2"	240091	3800154021145	1/100	9,35

ΔΙΑΚΟΠΤΗΣ ΚΑΛΟΡΙΦΕΡ ΓΩΝΙΑΚΟΣ ΓΙΑ ΘΕΡΜΟΣΤΑΤΙΚΗ ΚΕΦΑΛΗ
ΟΡΕΙΧΑΛΚΙΝΗ ΕΠΙΝΙΚΕΛΩΜΕΝΗ
RADIATOR VALVE FOR THERMOSTATIC HEAD ANGLE BRASS
NICKEL PLATED



ΔΙΑΣΤΑΣΗ Dimension	ΚΩΔΙΚΟΣ Item №	Barcode		ΤΙΜΗ
M30 x 1.5 1/2"	24008	3800154009716	1/100	9,04

ΔΙΑΚΟΠΤΗΣ ΚΑΛΟΡΙΦΕΡ ΓΩΝΙΑΚΟΣ ΓΙΑ ΘΕΡΜΟΣΤΑΤΙΚΗ ΚΕΦΑΛΗ
ΟΡΕΙΧΑΛΚΙΝΗ ΕΠΙΧΡΩΜΙΩΜΕΝΗ
RADIATOR VALVE FOR THERMOSTATIC HEAD ANGLE BRASS
CHROME PLATED



ΔΙΑΣΤΑΣΗ Dimension	ΚΩΔΙΚΟΣ Item №	Barcode		ΤΙΜΗ
M30 x 1.5 1/2"	240081	3800154021152	1/100	8,78

ΔΙΑΚΟΠΤΗΣ ΚΑΛΟΡΙΦΕΡ ΓΩΝΙΑΚΟΣ ΓΙΑ ΘΕΡΜΟΣΤΑΤΙΚΗ ΚΕΦΑΛΗ
ΜΕ ΑΝΤΑΠΤΟΡΑ ΟΡΕΙΧΑΛΚΙΝΗ ΕΠΙΝΙΚΕΛΩΜΕΝΗ
RADIATOR VALVE FOR THERMOSTATIC HEAD ANGLE BRASS
NICKEL PLATED



ΔΙΑΣΤΑΣΗ Dimension	ΚΩΔΙΚΟΣ Item №	Barcode		ΤΙΜΗ
M30 x 1.5 Ø 16 mm * 1/2"	24004	3800154009730	1/100	11,21

ΔΙΑΚΟΠΤΗΣ ΚΑΛΟΡΙΦΕΡ ΓΩΝΙΑΚΟΣ ΓΙΑ ΘΕΡΜΟΣΤΑΤΙΚΗ ΚΕΦΑΛΗ
ΜΕ ΑΝΤΑΠΤΟΡΑ ΟΡΕΙΧΑΛΚΙΝΗ ΕΠΙΧΡΩΜΙΩΜΕΝΗ
RADIATOR VALVE FOR THERMOSTATIC HEAD ANGLE BRASS
CHROME PLATED



ΔΙΑΣΤΑΣΗ Dimension	ΚΩΔΙΚΟΣ Item №	Barcode		ΤΙΜΗ
M30 x 1.5 Ø 16 mm * 1/2"	240041	3800154021169	1/100	10,69

TMS[®]
THERMOSTYLE



**ΔΙΑΚΟΠΤΗΣ ΚΑΛΟΡΙΦΕΡ ΙΣΙΟΣ ΓΙΑ ΘΕΡΜΟΣΤΑΤΙΚΗ ΚΕΦΑΛΗ
ΜΕ ΑΝΤΑΠΤΟΡΑ ΟΡΕΙΧΑΛΚΙΝΗ ΕΠΙΝΙΚΕΛΩΜΕΝΗ**
**RADIATOR VALVE FOR THERMOSTATIC HEAD STRAIGHT BRASS
NICKEL PLATED**



ΔΙΑΣΤΑΣΗ Dimension	ΚΩΔΙΚΟΣ Item №	Barcode		ΤΙΜΗ
M30 x 1.5 Ø 16 mm * 1/2"	24005	3800154009723	1/100	12,10

**ΔΙΑΚΟΠΤΗΣ ΚΛΕΙΣΙΜΑΤΟΣ M30x1,5 ΓΙΑ ΘΕΡΜΟΣΤΑΤΙΚΗ ΒΑΝΑ
ΜΕ ΣΚΑΛΕΣ**
**BRASS CARTAGE M30 x 1.5 FOR THERMOSTATIC VALVE
WITH RATES**



ΔΙΑΣΤΑΣΗ Dimension	ΚΩΔΙΚΟΣ Item №	Barcode		ΤΙΜΗ
Ø 16 mm * 1/2"	7588	3800154029837	1/100	3,77

ΒΕΝΤΙΛ ΡΑΔΙΑΤΟΡΕΝ ΠΡΑΒ ΖΑ ΤΕΡΜΟΓΛΑΒΑ 24*19
BRASS RADIATOR VALVE STRAIGHT FOR THERMOSTATIC HEAD 24*19



Размер Dimension	Αрт. № Item №	Баркод Barcode		ΤΙΜΗ
24 x 19 x 1/2"	6893	3800154029080	60	15,46

ΒΕΝΤΙΛ ΡΑΔΙΑΤΟΡΕΝ ΎΓΛΩΒ ΖΑ ΤΕΡΜΟΓΛΑΒΑ 24*19
BRASS RADIATOR VALVE ANGLE FOR THERMOSTATIC HEAD 24*19



Размер Dimension	Αрт. № Item №	Баркод Barcode		ΤΙΜΗ
24 x 19 x 1/2"	6892	3800154029073	60	14,07

ΔΙΑΚΟΠΤΗΣ ΚΑΛΟΡΙΦΕΡ ΙΣΙΟΣ ΟΡΕΙΧΑΛΚΙΝΟΣ ΕΠΙΝΙΚΕΛΩΜΕΝΟΣ
RADIATOR VALVE STRAIGHT BRASS NICKEL PLATED



ΔΙΑΣΤΑΣΗ Dimension	ΚΩΔΙΚΟΣ Item №	Barcode		ΤΙΜΗ
1/2"	2483	3800154009815	10/100	7,26

ΔΙΑΚΟΠΤΗΣ ΚΑΛΟΡΙΦΕΡ ΙΣΙΟΣ ΜΕ ΡΑΚΟΡ PEX-AL-PEX
**RADIATOR VALVE STRAIGHT FOR PEX-AL-PEX PIPE BRASS
NICKEL PLATED**



ΔΙΑΣΤΑΣΗ Dimension	ΚΩΔΙΚΟΣ Item №	Barcode		ΤΙΜΗ
Ø 16 mm * 1/2"	2462	3800154009792	10/100	7,26



ΘΕΡΜΑΝΣΗ HEATING

ΔΙΑΚΟΠΤΗΣ ΚΑΛΟΡΙΦΕΡ ΙΣΙΟΣ ΟΡΕΙΧ/ΝΟΣ ΜΕ ΒΑΛΒΙΔΑ ΑΣΦΑΛΕΙΑΣ
SAFETY RADIATOR VALVE STRAIGHT BRASS NICKEL PLATED



ΔΙΑΣΤΑΣΗ Dimension	ΚΩΔΙΚΟΣ Item N°	Barcode		ΤΙΜΗ
1/2"	160	3800154009822	20/200	5,69

ΔΙΑΚΟΠΤΗΣ ΚΑΛΟΡΙΦΕΡ ΙΣΙΟΣ ΜΕ ΒΑΛΒΙΔΑ ΑΣΦΑΛΕΙΑΣ ΚΑΙ ΡΑΚΟΡ PEX-AL-PEX
SAFETY RADIATOR VALVE STRAIGHT FOR PEX-AL-PEX PIPE BRASS NICKEL PLATED



ΔΙΑΣΤΑΣΗ Dimension	ΚΩΔΙΚΟΣ Item N°	Barcode		ΤΙΜΗ
Ø 16 mm * 1/2"	2482	3800154009839	13/130	6,05

ΔΙΑΚΟΠΤΗΣ ΚΑΛΟΡΙΦΕΡ ΓΩΝΙΑΚΟΣ
RADIATOR VALVE ANGLE BRASS NICKEL PLATED



ΔΙΑΣΤΑΣΗ Dimension	ΚΩΔΙΚΟΣ Item N°	Barcode		ΤΙΜΗ
1/2"	2481	3800154009846	10/100	6,94

ΔΙΑΚΟΠΤΗΣ ΚΑΛΟΡΙΦΕΡ ΓΩΝΙΑΚΟΣ ΜΕ ΡΑΚΟΡ PEX-AL-PEX
RADIATOR ANGLE VALVE FOR PEX-AL-PEX PIPE BRASS NICKEL PLATED



ΔΙΑΣΤΑΣΗ Dimension	ΚΩΔΙΚΟΣ Item N°	Barcode		ΤΙΜΗ
Ø 16 mm * 1/2"	2480	3800154009808	10/100	6,92

ΔΙΑΚΟΠΤΗΣ ΑΣΦΑΛΕΙΑΣ ΚΑΛΟΡΙΦΕΡ ΓΩΝΙΑΚΟΣ
SAFETY RADIATOR ANGLE VALVE BRASS NICKEL PLATED



ΔΙΑΣΤΑΣΗ Dimension	ΚΩΔΙΚΟΣ Item N°	Barcode		ΤΙΜΗ
1/2"	2461	3800154009853	20/200	6,29

ΔΙΑΚΟΠΤΗΣ ΑΣΦΑΛΕΙΑΣ ΚΑΛΟΡΙΦΕΡ ΓΩΝΙΑΚΟΣ ΜΕ ΡΑΚΟΡ PEX-AL-PEX
SAFETY RADIATOR ANGLE VALVE FOR PEX-AL-PEX PIPE BRASS NICKEL PLATED



ΔΙΑΣΤΑΣΗ Dimension	ΚΩΔΙΚΟΣ Item N°	Barcode		ΤΙΜΗ
Ø 16 mm * 1/2"	24810	3800154009860	15/150	6,52

THS[®]
THERMOSTYLE



ΘΕΡΜΟΣΤΑΤΙΚΗ ΚΕΦΑΛΗ ΜΕ ΚΛΕΙΔΩΜΑ THERMOSTATIC HEAD WITH LOCKER



ΔΙΑΣΤΑΣΗ Dimension	ΚΩΔΙΚΟΣ Item №	Barcode	 	ΤΙΜΗ
M30 x 1.5	6184	3800154023576	1/100	6,10

ΘΕΡΜΟΣΤΑΤΙΚΗ ΚΕΦΑΛΗ ΛΕΥΚΗ THERMOSTATIC HEAD SNOW WHITE



ΔΙΑΣΤΑΣΗ Dimension	ΚΩΔΙΚΟΣ Item №	Barcode	 	ΤΙΜΗ
M30 x 1.5	6185	3800154023583	1/100	6,42



ΘΕΡΜΟΣΤΑΤΙΚΗ ΚΕΦΑΛΗ ΜΕ ΥΓΡΟ THERMOSTATIC HEAD FOR RADIATOR VALVE



ΔΙΑΣΤΑΣΗ Dimension	ΚΩΔΙΚΟΣ Item №	Barcode	 	ΤΙΜΗ
M30 x 1.5	24007	3800154009747	1/100	5,92



ΘΕΡΜΟΣΤΑΤΙΚΗ ΚΕΦΑΛΗ ΧΡΩΜΕ THERMOSTATIC HEAD FOR RADIATOR VALVE CHROME PLATED



ΔΙΑΣΤΑΣΗ Dimension	ΚΩΔΙΚΟΣ Item №	Barcode	 	ΤΙΜΗ
M30 x 1.5	24006	3800154009754	1/100	8,25



ΘΕΡΜΟΣΤΑΤΙΚΗ ΚΕΦΑΛΗ ΛΕΥΚΗ THERMOSTATIC RADIATOR HEAD



ΔΙΑΣΤΑΣΗ Dimension	ΚΩΔΙΚΟΣ Item №	Barcode	 	ΤΙΜΗ
M30 x 1.5	7567	3800154029714	1/100	9,83

ΘΕΡΜΟΣΤΑΤΙΚΗ ΚΕΦΑΛΗ CAYMAN ΛΕΥΚΗ THERMOSTATIC RADIATOR HEAD CAYMAN WHITE





ΔΙΑΣΤΑΣΗ Dimension	ΚΩΔΙΚΟΣ Item №	Barcode	 	ΤΙΜΗ
M30 x 1.5	7570	3800154029745	1/100	10,58

ΘΕΡΜΑΝΣΗ HEATING



ΘΕΡΜΟΣΤΑΤΙΚΗ ΚΕΦΑΛΗ CAYMAN ΛΕΥΚΗ THERMOSTATIC RADIATOR HEAD CAYMAN WHITE



ΔΙΑΣΤΑΣΗ Dimension	ΚΩΔΙΚΟΣ Item №	Barcode	 	ΤΙΜΗ
M30 x 1.5	7571	3800154029752	1/100	10,58

ΘΕΡΜΟΣΤΑΤΙΚΗ ΚΕΦΑΛΗ CAYMAN ΜΑΥΡΗ THERMOSTATIC RADIATOR HEAD CAYMAN BLACK



ΔΙΑΣΤΑΣΗ Dimension	ΚΩΔΙΚΟΣ Item №	Barcode	 	ΤΙΜΗ
M30 x 1.5	7572	3800154029769	1/100	10,58



ΘΕΡΜΟΣΤΑΤΙΚΗ ΚΕΦΑΛΗ ΛΕΥΚΗ 20° - 60° THERMOSTATIC RADIATOR HEAD 20° - 60°



ΔΙΑΣΤΑΣΗ Dimension	ΚΩΔΙΚΟΣ Item №	Barcode	 	ΤΙΜΗ
M30 x 1.5	7573	3800154029776	1/50	20,31

ΘΕΡΜΟΣΤΑΤΙΚΗ ΚΕΦΑΛΗ ΛΕΥΚΗ 30° - 70° THERMOSTATIC RADIATOR HEAD 30° - 70°



ΔΙΑΣΤΑΣΗ Dimension	ΚΩΔΙΚΟΣ Item №	Barcode	 	ΤΙΜΗ
M30 x 1.5	7574	3800154029783	1/50	20,31



ΘΕΡΜΟΣΤΑΤΙΚΗ ΚΕΦΑΛΗ ΜΙΝΙ ΛΕΥΚΗ THERMOSTATIC RADIATOR HEAD MINI WHITE



ΔΙΑΣΤΑΣΗ Dimension	ΚΩΔΙΚΟΣ Item №	Barcode	 	ΤΙΜΗ
M30 x 1.5	7568	3800154029721	1/100	8,65

ΘΕΡΜΟΣΤΑΤΙΚΗ ΚΕΦΑΛΗ ΜΙΝΙ ΛΕΥΚΗ THERMOSTATIC RADIATOR HEAD MINI WHITE



ΔΙΑΣΤΑΣΗ Dimension	ΚΩΔΙΚΟΣ Item №	Barcode	 	ΤΙΜΗ
M30 x 1.5	7569	3800154029738	1/100	8,65

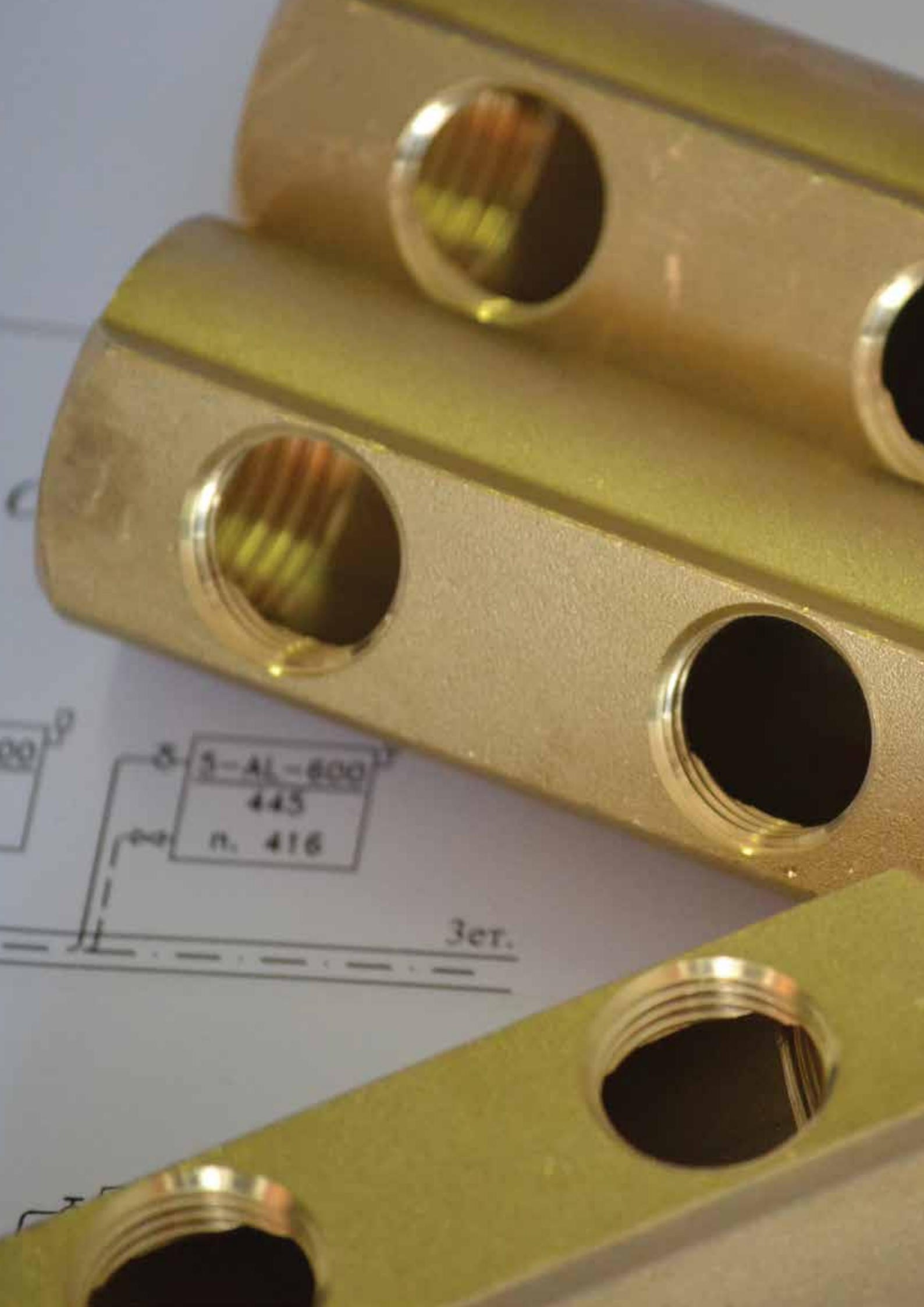

3-AL-800
445
n. 416

3er.

ΣΥΛΛΕΚΤΗΣ ΣΩΛΗΝΩΤΟΣ 3/4" BRASS FEMALE MANIFOLD 3/4" FF



ΔΙΑΣΤΑΣΗ Dimension	ΚΩΔΙΚΟΣ Item №	Barcode		ΤΙΜΗ
2 ΟΠΩΝ/ 2 WAYS	250	3800154022142	5/50	7,86
3 ΟΠΩΝ/ 2 WAYS	2501	3800154022159	5/30	11,79
4 ΟΠΩΝ/ 2 WAYS	2502	3800154022166	5/30	15,72
5 ΟΠΩΝ/ 2 WAYS	2491	3800154022173	5/15	19,65
6 ΟΠΩΝ/ 2 WAYS	2492	3800154022180	5/20	23,58
7 ΟΠΩΝ/ 2 WAYS	2493	3800154025327	5/20	27,51
8 ΟΠΩΝ/ 2 WAYS	2494	3800154025334	5/20	31,44
9 ΟΠΩΝ/ 2 WAYS	2495	3800154025341	5/20	35,37
10 ΟΠΩΝ/ 2 WAYS	2496	3800154025310	5/20	39,30

ΣΥΛΛΕΚΤΗΣ ΣΩΛΗΝΩΤΟΣ 1" BRASS FEMALE MANIFOLD 1" FF



ΔΙΑΣΤΑΣΗ Dimension	ΚΩΔΙΚΟΣ Item №	Barcode		ΤΙΜΗ
2 ΟΠΩΝ/ 2 WAYS	241	3800154009112	5/50	10,74
3 ΟΠΩΝ/ 3 WAYS	242	3800154009129	5/40	13,76
4 ΟΠΩΝ/ 4 WAYS	243	3800154009136	5/25	18,34
5 ΟΠΩΝ/ 5 WAYS	244	3800154009143	5/20	22,93
6 ΟΠΩΝ/ 6 WAYS	245	3800154009150	5/20	27,51
7 ΟΠΩΝ/ 7 WAYS	246	3800154009167	5/20	32,10
8 ΟΠΩΝ/ 8 WAYS	247	3800154009174	5/20	36,68
9 ΟΠΩΝ/ 9 WAYS	248	3800154009181	5/20	41,27
10 ΟΠΩΝ/ 10 WAYS	249	3800154009198	5/20	45,85

ΣΥΛΛΕΚΤΗΣ ΣΩΛΗΝΩΤΟΣ 1 1/4" BRASS FEMALE MANIFOLD 1 1/4" FF



ΔΙΑΣΤΑΣΗ Dimension	ΚΩΔΙΚΟΣ Item №	Barcode		ΤΙΜΗ
2 ΟΠΩΝ/ 2 WAYS	2414	3800154025150	10/30	10,48
3 ΟΠΩΝ/ 3 WAYS	2458	3800154022197	10/20	15,72
4 ΟΠΩΝ/ 4 WAYS	2459	3800154022203	10/15	26,46
5 ΟΠΩΝ/ 5 WAYS	2444	3800154025167	5/10	26,20
6 ΟΠΩΝ/ 6 WAYS	2445	3800154025174	5/10	31,44
7 ΟΠΩΝ/ 7 WAYS	24102	3800154025181	5/10	44,49
8 ΟΠΩΝ/ 8 WAYS	24103	3800154025198	5/10	52,92
9 ΟΠΩΝ/ 9 WAYS	24105	3800154025204	5/10	47,16
10 ΟΠΩΝ/ 10 WAYS	24106	3800154025211	5/10	66,16

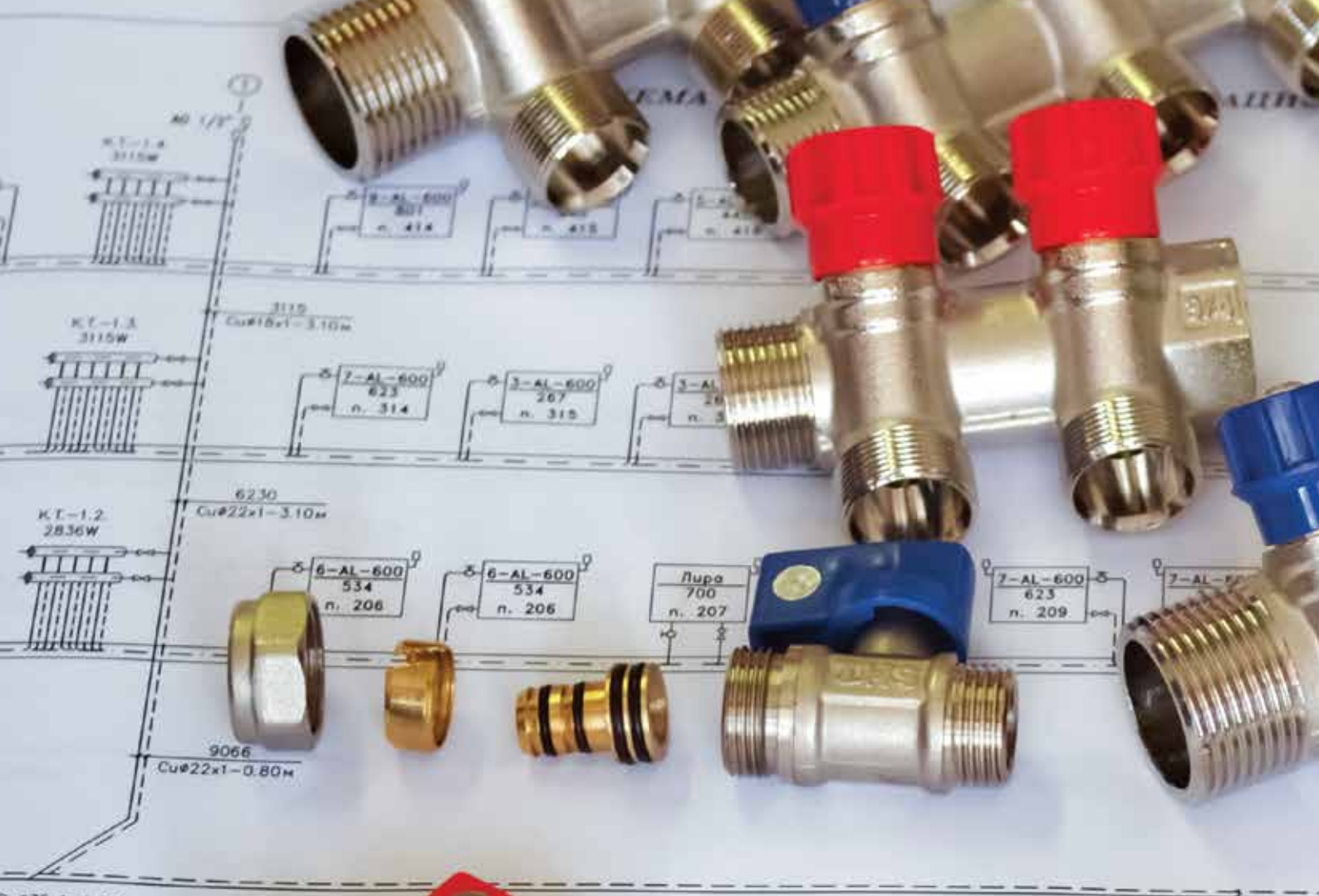
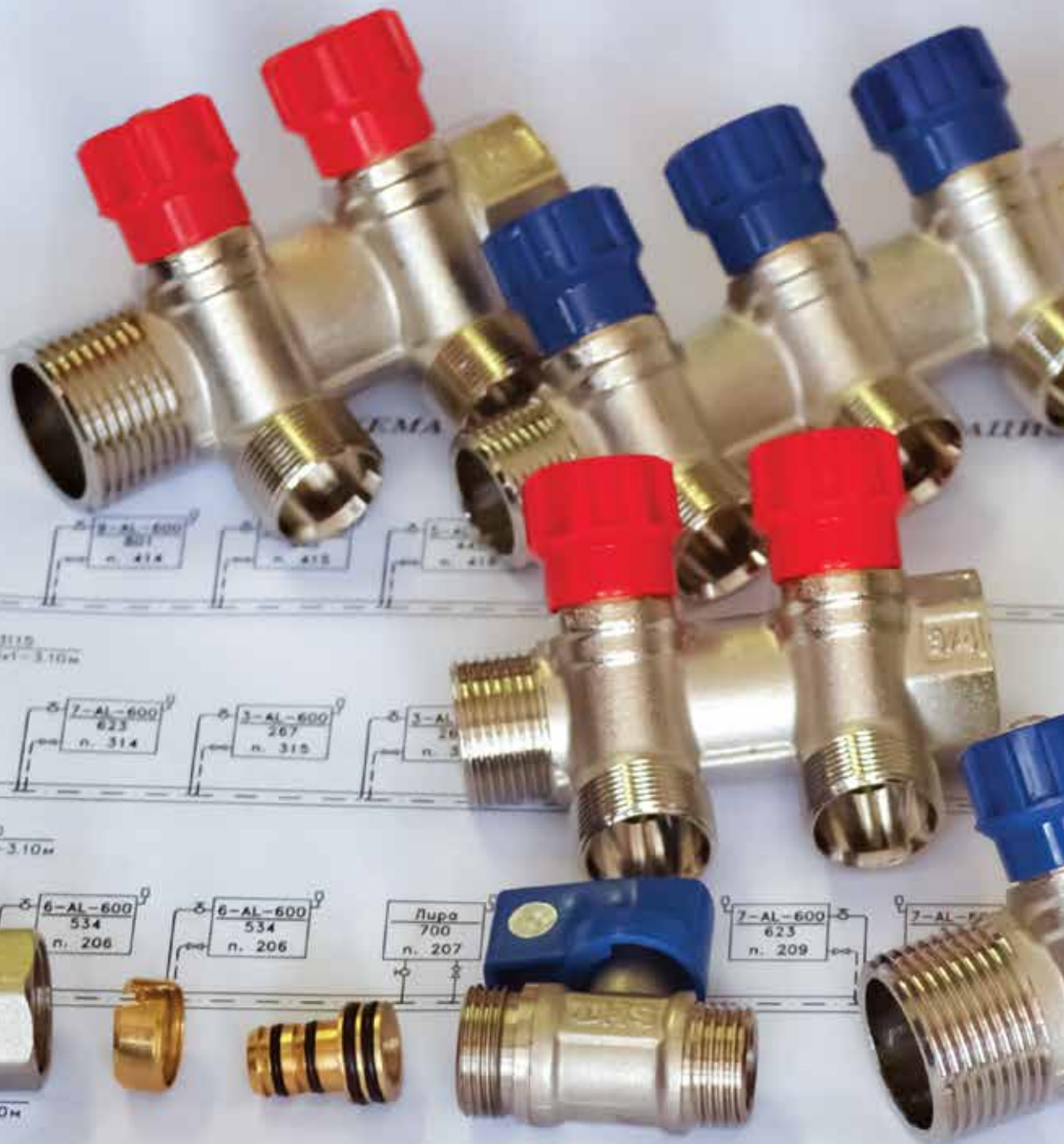
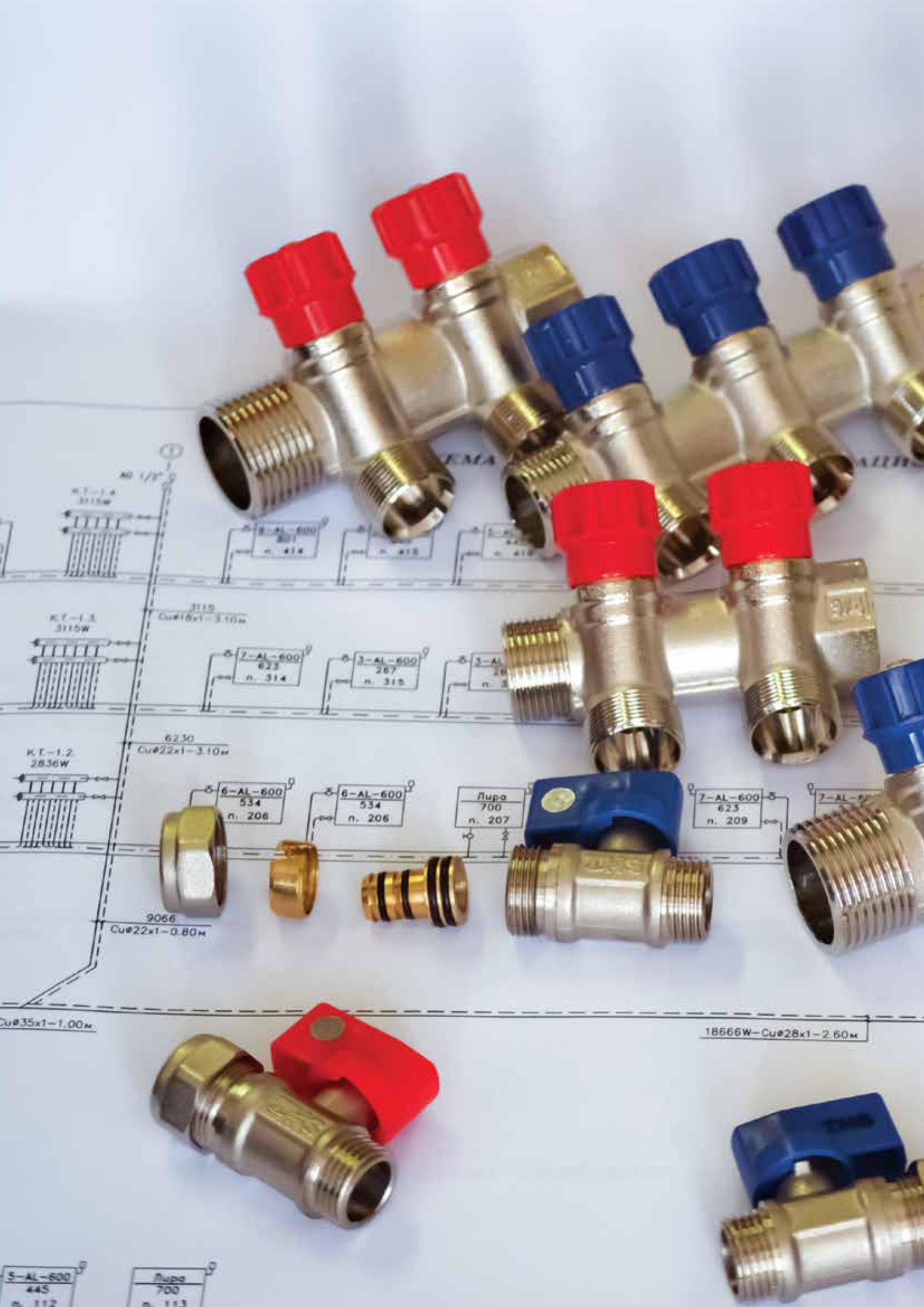

18666W-Cu#28x1-2.60m

5-AL-600
445
n. 112

Лупа
700
n. 113

ΘΕΡΜΑΝΣΗ HEATING



ΣΥΛΛΕΚΤΗΣ ΓΩΝΙΑΚΟΣ 3/4" ΑΘ ΜΕ ΠΑΚΟΠ AL-PEX Ø16mm
BRASS MANIFOLD 3/4" FM WITH ADAPTOR AND STOP VALVE Ø 16 mm

ΣΥΛΛΕΚΤΗΣ ΓΩΝΙΑΚΟΣ 1" Α-Θ ΜΕ ΠΑΚΟΠ AL-PEX Ø 16 mm
BRASS MANIFOLD 1" FM WITH ADAPTOR AND STOP VALVE Ø 16 mm



ΔΙΑΣΤΑΣΗ Dimension	ΚΩΔΙΚΟΣ Item №	Barcode		ΤΙΜΗ
2 ΟΠΩΝ/ 2 WAYS	241602	3800154042133	1/40	22,35
3 ΟΠΩΝ/ 3 WAYS	241603	3800154042126	1/30	31,83
4 ΟΠΩΝ/ 4 WAYS	241604	3800154042119	1/25	41,45

ΔΙΑΣΤΑΣΗ Dimension	ΚΩΔΙΚΟΣ Item №	Barcode		ΤΙΜΗ
2 ΟΠΩΝ/ 2 WAYS	241702	3800154009235	1/25	24,97
3 ΟΠΩΝ/ 3 WAYS	241703	3800154009242	1/20	35,03
4 ΟΠΩΝ/ 4 WAYS	241704	3800154009259	1/15	45,20

ΣΥΛΛΕΚΤΗΣ ΓΩΝΙΑΚΟΣ 3/4" ΜΕ ΣΠΕΙΡΩΜΑ 24x19
BRASS MANIFOLDS WITH STOP VALVES 3/4" 24 x 19

ΣΥΛΛΕΚΤΗΣ ΓΩΝΙΑΚΟΣ 1" ΜΕ ΣΠΕΙΡΩΜΑ 24x19
BRASS MANIFOLDS WITH STOP VALVES 1" 24 x 19



ΔΙΑΣΤΑΣΗ Dimension	ΚΩΔΙΚΟΣ Item №	Barcode		ΤΙΜΗ
2 ΟΠΩΝ/ 2 WAYS	6223	3800154023798	1/25	19,62
3 ΟΠΩΝ/ 3 WAYS	6224	3800154023804	1/20	27,59
4 ΟΠΩΝ/ 4 WAYS	6225	3800154023811	1/20	35,45

ΔΙΑΣΤΑΣΗ Dimension	ΚΩΔΙΚΟΣ Item №	Barcode		ΤΙΜΗ
2 ΟΠΩΝ/ 2 WAYS	241705	3800154023767	1/25	23,11
3 ΟΠΩΝ/ 3 WAYS	241706	3800154023774	1/20	33,38
4 ΟΠΩΝ/ 4 WAYS	241707	3800154023781	1/15	42,94

ΣΥΛΛΕΚΤΗΣ ΟΡΕΙΧΑΛΚΙΝΟΣ 1" ΜΕ ΜΕΤΡΗΤΗ ΡΟΗΣ 24x19 BRASS MANIFOLDS WITH FLOW METER FM 1", 24 x 19

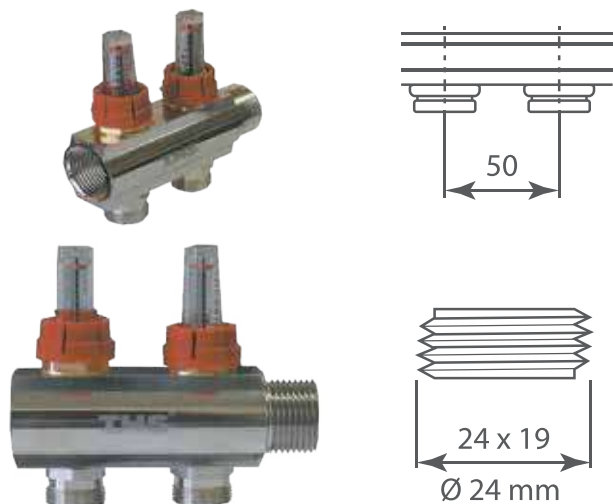

ΔΙΑΣΤΑΣΗ Dimension	ΚΩΔΙΚΟΣ Item N°	Barcode		ΤΙΜΗ
2 ΟΠΩΝ/ 2 WAYS	7590	3800154029936	1/30	29,63
3 ΟΠΩΝ/ 3 WAYS	7591	3800154029943	1/20	38,85
4 ΟΠΩΝ/ 4 WAYS	7592	3800154029950	1/15	51,38
5 ΟΠΩΝ/ 5 WAYS	7593	3800154029967	1/10	63,88

ΣΥΛΛΕΚΤΗΣ ΟΡΕΙΧΑΛΚΙΝΟΣ 1" 24x19 BRASS MANIFOLDS WITH HANDLE FM 1", 24 x 19

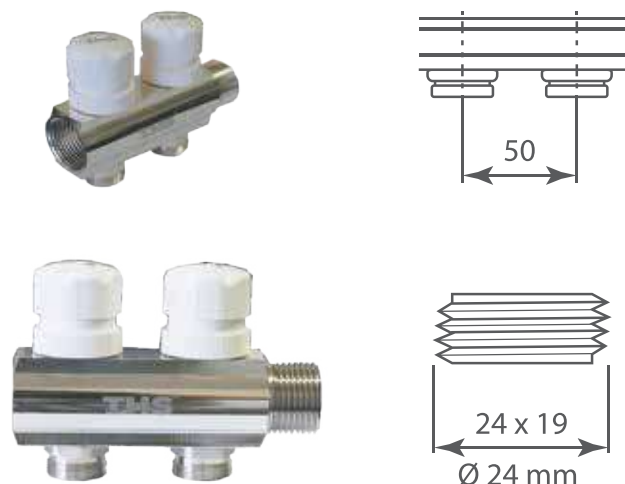

ΔΙΑΣΤΑΣΗ Dimension	ΚΩΔΙΚΟΣ Item N°	Barcode		ΤΙΜΗ
2 ΟΠΩΝ/ 2 WAYS	7594	3800154029974	1/30	24,42
3 ΟΠΩΝ/ 3 WAYS	7595	3800154029981	1/20	33,22
4 ΟΠΩΝ/ 4 WAYS	7596	3800154029998	1/15	43,96
5 ΟΠΩΝ/ 5 WAYS	7597	3800154030000	1/10	54,57

ΓΚΡΟΥΠ ΣΥΛΛΕΚΤΩΝ 1" 24x19 BRASS MANIFOLDS SET FF 1", 24 x 19

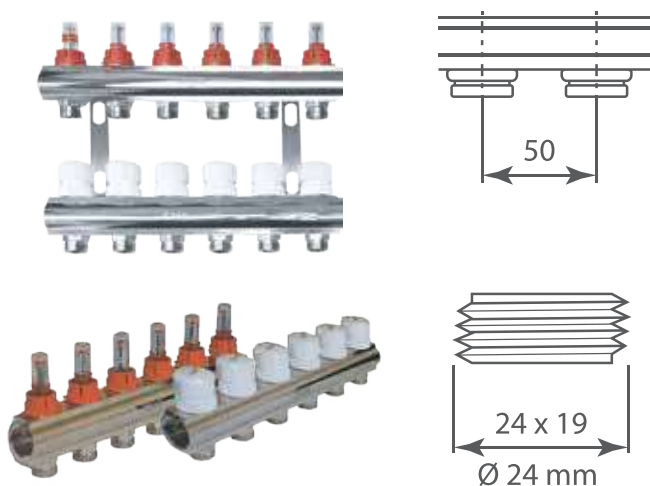

ΔΙΑΣΤΑΣΗ Dimension	ΚΩΔΙΚΟΣ Item N°	Barcode		ΤΙΜΗ
6 ΟΠΩΝ/ 6 WAYS	7887	3800154031496	1/1	144,18
7 ΟΠΩΝ/ 7 WAYS	7895	3800154031502	1/1	158,80
8 ΟΠΩΝ/ 8 WAYS	7899	3800154031519	1/1	180,78
9 ΟΠΩΝ/ 9 WAYS	7903	3800154031526	1/1	202,92
10 ΟΠΩΝ/ 10WAYS	7905	3800154031533	1/1	225,03

ΣΤΗΡΙΓΜΑΤΑ ΓΙΑ ΓΚΡΟΥΠ ΣΥΛΛΕΚΤΩΝ 2ΤΜΧ BRACKETS FOR MANIFOLDS - SET OF 2 PCS



ΔΙΑΣΤΑΣΗ Dimension	ΚΩΔΙΚΟΣ Item N°	Barcode		ΤΙΜΗ
	7598	3800154030017	1/40	6,29

ΘΕΡΜΑΝΣΗ HEATING

ΗΛΕΚΤΡΙΚΗ ΜΟΝΑΔΑ ΜΕ 2 ΑΓΩΓΟΥΣ ΚΑΛΩΔΙΟ 90cm ELECTRIC THERMAL ACTUATOR CABLE 90 cm



- Παροχή ηλεκτρικού ρεύματος 230V
Power supply 230V
- Χαμηλή κατανάλωση 2W
Low power consumption 2W
- Ευκολία στην εγκατάσταση
Easy to install
- Αντοχή 110N
Endurance 110N
- Ορατό στοιχείο που δείχνει άνοιγμα ή κλείσιμο
Visible item showing opening or closing
- IP54

ΔΙΑΣΤΑΣΗ Dimension	ΚΩΔΙΚΟΣ Item №	Barcode		TIMH
M30X1.5-230V4P54-110N	7599	3800154030024	1/100	19,26

ΣΕΤ ΡΟΟΜΕΤΡΟ ΚΑΙ ΜΗΧΑΝΙΣΜΟΣ ΚΛΕΙΣΙΜΑΤΟΣ SET FOR FLOW METER AND CARTAGE



- Κλίμακα ροής υγρού
0 έως 5 l/m
Fluid flow scale: 0 to 5 liters / minute
- Υλικό επάνω μέρους ρυθμιστή
– πολυανθρακικό με αντοχή μέχρι 110 °C
Upper flowmeter material - polycarbonate,
withstands up to 110 °C
- Υλικό βάσης – Ορείχαλκος
Base material - brass
- Υλικό εσωτερικού ελατηρίου
Ανοξείδωτο ατσάλι
Inner spring material - stainless steel

ΔΙΑΣΤΑΣΗ Dimension	ΚΩΔΙΚΟΣ Item №	Barcode		TIMH
	7908	3800154031540	1/200	10,35

ΣΕΤ ΘΕΡΜΑΝΣΗΣ ΚΟΜΠΛΕ MIXING PUMP UNIT

Technical data		Τεχνικά χαρακτηριστικά
The maximum temperature primary circuit	90 °C	Μέγιστη θερμοκρασία στο πρωταρχικό κύκλωμα
The maximum pressure	10bar	Μέγιστη πίεση
The maximum pressure drop primary circuit, other max.	1bar	Μέγιστη μείωση της πίεσης στο πρωταρχικό κύκλωμα
Control range in the secondary circuit (range of regulation thermostat head)	20-60 °C / 30-70 °C	Περιοχή ελέγχου στο δευτερεύον κύκλωμα (εύρος ελέγχου της θερμοστατικής κεφαλής)
Bypass the position of 0	10kw	By-pass σε θέση 0
Bypass the position of 5	12.5kw	By-pass σε θέση 5
Loss of pressure on the mixing valve (bypass the position of 0)	Kv3	Απώλεια πίεσης της βαλβίδας μίξης (να αποφεύγεται η θέση 0)
Loss of pressure on the mixing valve (bypass the position of 5)	Kvmax4.8	Απώλεια πίεσης της βαλβίδας μίξης (να αποφεύγεται η θέση 5)
Scale thermometer	0-120 °C	Κλίμακα θερμομέτρου
The diameter of the connection to the high-temperature contour	1"	Διάμετρος σπειρώματος σύνδεσης του κολλετέρ εισαγωγής συλλέκτης τροφοδοσίας
The diameter of the connection to the low-temperature contour	1"	Διάμετρος σπειρώματος σύνδεσης του κολλετέρ εξαγωγής συλλέκτης τροφοδοσίας
Connection diameter and mounting length of circulation pump	1 1/4"	Διάμετρος σπειρώματος σύνδεσης και μήκος επέκτασης της αντλίας κυκλοφορίας

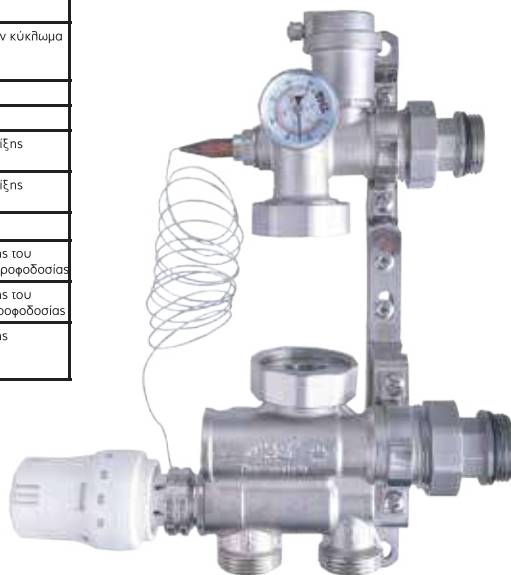



ΔΙΑΣΤΑΣΗ Dimension	ΚΩΔΙΚΟΣ Item №	Barcode		TIMH
1"	7589	3800154029844	1/5	185,78

TMS
THERMOSTYLE





ΡΑΚΟΡ ΣΥΛΛΕΚΤΗ ΡΕΧ-ΑΛ-ΡΕΧ FITTING PEX-AL-PEX



ΔΙΑΣΤΑΣΗ Dimension	ΚΩΔΙΚΟΣ Item №	Barcode		ΤΙΜΗ
24 x 19 Ø 16 mm	241708	3800154023644		3,56
24 x 19 Ø 20 mm	5939	3800154023682		3,83



ΞΑΡΤΗΜΑΤΑ ΑΠΟΣΤΡΑΓΓΙΣΗΣ ΓΙΑ ΚΟΛΕΚΤΕΡ SEWAGE BRASS MINI BALL VALVE FOR MANIFOLD



ΔΙΑΣΤΑΣΗ Dimension	ΚΩΔΙΚΟΣ Item №	Barcode		ΤΙΜΗ
1/2"	4013	3800154009266		5,21







ΑΚΡΟΦΥΣΙΟ ΜΕ ΑΥΤΟΜΑΤΟ ΞΑΕΡΙΣΤΙΚΟ ΚΑΙ ΔΙΑΚΟΠΤΗΣ ΑΠΟΣΤΡΑΓΓΙΣΗΣ BRASS END TEE WITH AUTOMATIC AIR VENT AND SEWAGE BRASS MINI VALVE



ΔΙΑΣΤΑΣΗ Dimension	ΚΩΔΙΚΟΣ Item №	Barcode		ΤΙΜΗ
1"	2428	3800154009273		15,82
1 1/4"	2433	3800154009280		20,38



ΑΚΡΟΦΥΣΙΟ(ΤΕΛΕΙΩΜΑ) ΓΙΑ ΚΟΛΕΚΤΕΡ Θ-Α-Θ BRASS END TEE FOR MANIFOLD FMF



ΔΙΑΣΤΑΣΗ Dimension	ΚΩΔΙΚΟΣ Item №	Barcode		ΤΙΜΗ
1/2" * 3/4" * 1/2"	24761	3800154024153		3,46
1/2" * 1" * 1/2"	2476	3800154009297		4,19
1/2" * 1 1/4" * 1/2"	6769	3800154028243		5,71
1/2" * 3/4" * 1/2"	9043	3800154033254		3,75
1/2" * 1" * 1/2"	9042	3800154033247		4,06



ΤΕΡΜΑΤΙΚΟ ΓΙΑ ΚΟΛΕΚΤΕΡ Α-Θ BRASS BUSHING FOR MANIFOLD WITH RUBBER FM



ΔΙΑΣΤΑΣΗ Dimension	ΚΩΔΙΚΟΣ Item №	Barcode		ΤΙΜΗ
1" * 1/2"	2411	3800154023194		1,26

ΤΑΠΑ ΓΙΑ ΚΟΛΕΚΤΕΡ BRASS END CAP FOR MANIFOLD WITH RUBBER MALE



ΔΙΑΣΤΑΣΗ Dimension	ΚΩΔΙΚΟΣ Item №	Barcode		ΤΙΜΗ
1"	2412	3800154023200		1,55

ΜΑΣΤΟΣ 24x19 CONNECTOR 24 x 19

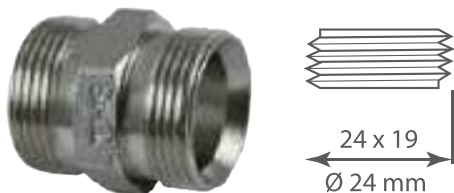

ΔΙΑΣΤΑΣΗ Dimension	ΚΩΔΙΚΟΣ Item №	Barcode		ΤΙΜΗ
24 x 19 x 24 x 19	6216	3800154024894	10/500	1,36

ΜΑΣΤΟΣ ΑΡΣΕΝΙΚΟΣ 24x19 NIPPEL MALE 24 x 19

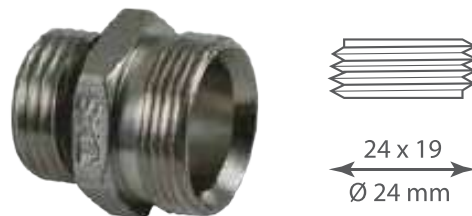

ΔΙΑΣΤΑΣΗ Dimension	ΚΩΔΙΚΟΣ Item №	Barcode		ΤΙΜΗ
24 x 19 x 1/2"	6214	3800154023613	10/500	1,62
24 x 19 x 3/4"	6226	3800154037504	10/280	1,97

ΜΑΣΤΟΣ ΘΗΛΥΚΟΣ 24x19 NIPPEL FEMALE 24 x 19



ΔΙΑΣΤΑΣΗ Dimension	ΚΩΔΙΚΟΣ Item №	Barcode		ΤΙΜΗ
24 x 19 x 1/2"	6215	3800154023620	10/450	1,36
24 x 19 x 3/4"	6230	3800154037511	10/280	2,07

ΓΩΝΙΑ ΑΡΣΕΝΙΚΗ 24x19 ELBOW MALE 24 x 19

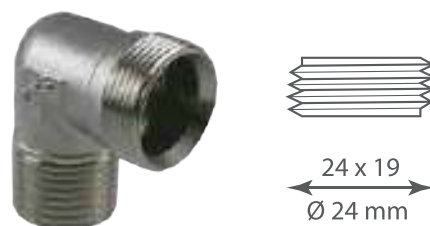

ΔΙΑΣΤΑΣΗ Dimension	ΚΩΔΙΚΟΣ Item №	Barcode		ΤΙΜΗ
24 x 19 x 1/2"	6217	3800154023637	10/250	2,12
24 x 19 x 3/4"	9398	3800154037528	10/150	3,38

ΓΩΝΙΑ ΘΗΛΥΚΗ 24x19 ELBOW FEMALE 24 x 19

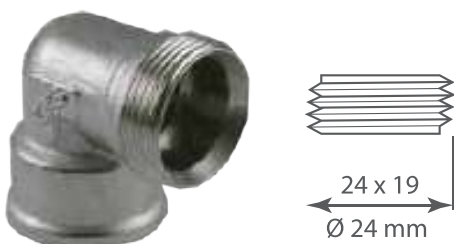

ΔΙΑΣΤΑΣΗ Dimension	ΚΩΔΙΚΟΣ Item №	Barcode		ΤΙΜΗ
24 x 19 x 1/2"	6218	3800154024924	10/250	2,46
24 x 19 x 3/4"	9399	3800154037535	10/150	3,38

ΓΩΝΙΑ 24x19 ELBOW 24 x 19

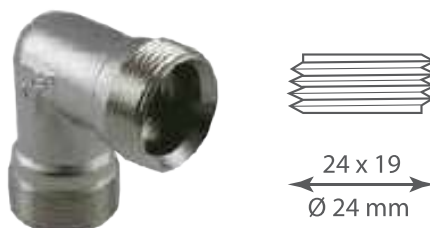

ΔΙΑΣΤΑΣΗ Dimension	ΚΩΔΙΚΟΣ Item №	Barcode		ΤΙΜΗ
24 x 19 x 24 x 19	6219	3800154023699	10/240	2,65

ΤΑΦ ΑΡΣΕΝΙΚΟ 24x19
TEE BRASS MMM 24 x 19

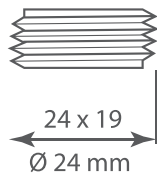

ΔΙΑΣΤΑΣΗ Dimension	ΚΩΔΙΚΟΣ Item N°	Barcode		ΤΙΜΗ
24 x 19 x 1/2" x 24 x 19	6220	3800154024900	10/180	2,99

ΤΑΦ ΘΗΛΥΚΟ 24x19
TEE FEMALE 24 x 19

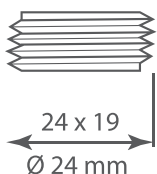

ΤΑΦ 24x19
TEE 24 x 19

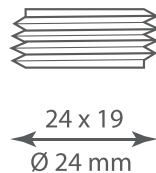

ΔΙΑΣΤΑΣΗ Dimension	ΚΩΔΙΚΟΣ Item N°	Barcode		ΤΙΜΗ
24 x 19 x 1/2" x 24 x 19	6221	3800154024917	10/160	3,77

ΔΙΑΣΤΑΣΗ Dimension	ΚΩΔΙΚΟΣ Item N°	Barcode		ΤΙΜΗ
24x19x24x19x24x19	6222	3800154023705	10/180	2,62



ΡΑΚΟΡ ΑΡΣΕΝΙΚΟ ΣΥΣΦΙΞΗΣ ΠΟΛΥΣΤΡΩΜΑΤΙΚΗΣ STRAIGHT FITTING FOR PEX AL PEX PIPE MALE



ΔΙΑΣΤΑΣΗ Dimension	ΚΩΔΙΚΟΣ Item №	Barcode		ΤΙΜΗ
Ø16 x 1/2"	2570	3800154009983	10/300	2,65
Ø16 x 3/4"	25104	3800154009990	10/240	3,25
Ø18 x 1/2"	2580	3800154010156	15/240	3,48
Ø20 x 1/2"	2590	3800154010262	10/210	4,17
Ø20 x 3/4"	2592	3800154010279	10/180	4,35

ΡΑΚΟΡ ΘΗΛΥΚΟ ΣΥΣΦΙΞΗΣ ΠΟΛΥΣΤΡΩΜΑΤΙΚΗΣ STRAIGHT FITTING FOR PEX AL PEX PIPE FEMALE



ΔΙΑΣΤΑΣΗ Dimension	ΚΩΔΙΚΟΣ Item №	Barcode		ΤΙΜΗ
Ø16 * 1/2"	2571	3800154010002	10/270	2,70
Ø16 * 3/4"	25105	3800154010019	10/210	3,59
Ø18 x 1/2"	2581	3800154010170	15/240	3,43
Ø20 x 1/2"	2593	3800154010286	10/180	4,51
Ø20 * 3/4"	2594	3800154010293	10/160	4,43

ΡΑΚΟΡ ΣΥΝΔΕΣΗΣ ΣΥΣΦΙΞΗΣ ΠΟΛΥΣΤΡΩΜΑΤΙΚΗΣ STRAIGHT FITTING FOR PEX AL PEX PIPE EQUAL



ΔΙΑΣΤΑΣΗ Dimension	ΚΩΔΙΚΟΣ Item №	Barcode		ΤΙΜΗ
Ø16 * Ø16	2572	3800154010026	10/240	3,88
Ø18 * Ø18	2582	3800154010194	10/180	5,48
Ø20 * Ø20	2595	3800154010309	10/150	6,50

ΓΩΝΙΑ ΑΡΣΕΝΙΚΗ ΣΥΣΦΙΞΗΣ ΠΟΛΥΣΤΡΩΜΑΤΙΚΗΣ ELBOW FOR PEX AL PEX PIPE MALE



ΔΙΑΣΤΑΣΗ Dimension	ΚΩΔΙΚΟΣ Item №	Barcode		ΤΙΜΗ
Ø16 * 1/2"	2573	3800154010033	15/240	3,14
Ø18 * 1/2"	2583	3800154010200	10/180	2,75
Ø20 x 1/2"	2596	3800154010316	10/150	5,11
Ø20 x 3/4"	2597	3800154010323	10/140	5,14

ΓΩΝΙΑ ΘΗΛΥΚΗ ΣΥΣΦΙΞΗΣ ΠΟΛΥΣΤΡΩΜΑΤΙΚΗΣ ELBOW FOR PEX AL PEX PIPE FEMALE



ΔΙΑΣΤΑΣΗ Dimension	ΚΩΔΙΚΟΣ Item №	Barcode		ΤΙΜΗ
Ø16 * 1/2"	2574	3800154010057	10/180	3,64
Ø20 * 1/2"	2598	3800154010330	10/130	5,11
Ø20 * 3/4"	2599	3800154010347	10/120	6,29

ΓΩΝΙΑ ΣΥΝΔΕΣΗΣ ΣΥΣΦΙΞΗΣ ΠΟΛΥΣΤΡΩΜΑΤΙΚΗΣ ELBOW FOR PEX AL PEX PIPE EQUAL



ΔΙΑΣΤΑΣΗ Dimension	ΚΩΔΙΚΟΣ Item N°	Barcode		ΤΙΜΗ
Ø 16 x Ø 16	2576	3800154010071	10/160	4,66
Ø 18 x Ø 18	2587	3800154010224	10/120	5,06
Ø 20 x Ø 20	25100	3800154010354	10/120	7,18

ΓΩΝΙΑ ΘΗΛΥΚΗ ΣΥΣΦΙΞΗΣ ΠΟΛΥΣΤΡΩΜΑΤΙΚΗΣ ELBOW FOR WALL FOR PEX AL PEX PIPE



ΔΙΑΣΤΑΣΗ Dimension	ΚΩΔΙΚΟΣ Item N°	Barcode		ΤΙΜΗ
Ø 16 x 1/2"	2579	3800154010132	10/120	4,72

ΤΑΦ ΑΡΣΕΝΙΚΟ ΣΥΣΦΙΞΗΣ ΠΟΛΥΣΤΡΩΜΑΤΙΚΗΣ TEE FOR PEX AL PEX PIPE MALE



ΔΙΑΣΤΑΣΗ Dimension	ΚΩΔΙΚΟΣ Item N°	Barcode		ΤΙΜΗ
Ø 16 x 1/2" x Ø 16	2546	3800154010088	10/160	3,43
Ø 20 x 1/2" x Ø 20	25111	3800154010361	10/140	
Ø 20 x 3/4" x Ø 20	2548	3800154010378	5/100	

ΤΑΦ ΘΗΛΥΚΟ ΣΥΣΦΙΞΗΣ ΠΟΛΥΣΤΡΩΜΑΤΙΚΗΣ TEE FOR PEX AL PEX PIPE FEMALE



ΔΙΑΣΤΑΣΗ Dimension	ΚΩΔΙΚΟΣ Item N°	Barcode		ΤΙΜΗ
Ø 16 x 1/2" x Ø 16	2577	3800154010095	5/100	5,76
Ø 20 x 1/2" x Ø 20	25101	3800154010385	5/80	
Ø 20 x 3/4" x Ø 20	25102	3800154010392	5/80	

ΤΑΦ ΣΥΝΔΕΣΗΣ ΣΥΣΦΙΞΗΣ ΠΟΛΥΣΤΡΩΜΑΤΙΚΗΣ TEE FOR PEX AL PEX PIPE EQUAL



ΔΙΑΣΤΑΣΗ Dimension	ΚΩΔΙΚΟΣ Item N°	Barcode		ΤΙΜΗ
Ø 16 x Ø 16 x Ø 16	2578	3800154010125	10/100	6,45
Ø 18 x Ø 18 x Ø 18	2589	3800154010255	5/80	5,92
Ø 20 x Ø 20 x Ø 20	25103	3800154010408	10/70	10,22

ΣΥΣΤΟΛΙΚΟ ΤΑΦ ΣΥΝΔΕΣΗΣ ΣΥΣΦΙΞΗΣ ΠΟΛΥΣΤΡΩΜΑΤΙΚΗΣ TEE FOR PEX AL PEX PIPE EQUAL REDUCTIVE



ΔΙΑΣΤΑΣΗ Dimension	ΚΩΔΙΚΟΣ Item N°	Barcode		ΤΙΜΗ
Ø 16 x Ø 16 x Ø 20	2532	3800154010422	5/90	7,94
Ø 16 x Ø 20 x Ø 16	2537	3800154010453	5/90	8,65
Ø 20 x Ø 16 x Ø 20	2535	3800154010439	10/80	8,91
Ø 16 x Ø 20 x Ø 20	2536	3800154010446	10/80	9,38

ΠΑΚΟΡ ΑΡΣΕΝΙΚΟ PRESS PRESS FITTING FOR PEX AL PEX STRAIGH MALE



ΔΙΑΣΤΑΣΗ Dimension	ΚΩΔΙΚΟΣ Item N°	Barcode		ΤΙΜΗ
Ø 16 x 1/2"	25000	3800154010460	10/400	2,38
Ø 16 x 3/4"	25002	3800154010477	20/400	3,07
Ø 20 x 1/2"	25015	3800154010590	10/360	2,99
Ø 20 x 3/4"	25016	3800154010606	10/270	3,33

ΠΑΚΟΡ ΘΗΛΥΚΟ PRESS PRESS FITTING FOR PEX AL PEX STRAIGH FEMALE



ΔΙΑΣΤΑΣΗ Dimension	ΚΩΔΙΚΟΣ Item N°	Barcode		ΤΙΜΗ
Ø 16 x 1/2"	25003	3800154010484	10/400	2,72
Ø 16 x 3/4"	25004	3800154010491	15/400	3,72
Ø 20 x 1/2"	25017	3800154010613	10/320	3,46
Ø 20 x 3/4"	25018	3800154010620	10/240	5,11

ΠΑΚΟΡ ΣΥΝΔΕΣΗΣ PRESS PRESS FITTING FOR PEX AL PEX STRAIGH



ΔΙΑΣΤΑΣΗ Dimension	ΚΩΔΙΚΟΣ Item N°	Barcode		ΤΙΜΗ
Ø 16 x 16	25005	3800154010507	10/400	2,44
Ø 20 x 20	25019	3800154010637	10/270	3,01

ΠΑΚΟΡ ΣΥΣΤΟΛΙΚΟ ΣΥΝΔΕΣΗΣ PRESS PRESS FITTING FOR PEX AL PEX STRAIGH REDUCING



ΔΙΑΣΤΑΣΗ Dimension	ΚΩΔΙΚΟΣ Item N°	Barcode		ΤΙΜΗ
Ø 20 x 16	25031	3800154029097	10/300	2,83

ΓΩΝΙΑ ΑΡΣΕΝΙΚΗ PRESS PRESS FITTING FOR PEX AL PEX ELBOW MALE



ΔΙΑΣΤΑΣΗ Dimension	ΚΩΔΙΚΟΣ Item N°	Barcode		ΤΙΜΗ
Ø 16 x 1/2"	25006	3800154010514	10/280	3,85
Ø 16 x 3/4"	25007	3800154026782	10/320	
Ø 20 x 1/2"	25020	3800154010644	10/210	4,14
Ø 20 x 3/4"	25021	3800154010651	10/180	5,06

ΓΩΝΙΑ ΣΥΣΤΟΛΙΚΗ ΣΥΝΔΕΣΗΣ PRESS PRESS FITTING FOR PEX AL PEX ELBOW REDUCING



ΔΙΑΣΤΑΣΗ Dimension	ΚΩΔΙΚΟΣ Item N°	Barcode		ΤΙΜΗ
Ø 20 x 16	25032	3800154026799	10/240	3,98

ΓΩΝΙΑ ΘΗΛΥΚΗ PRESS PRESS FITTING FOR PEX AL PEX ELBOW FEMALE



ΔΙΑΣΤΑΣΗ Dimension	ΚΩΔΙΚΟΣ Item N°	Barcode		ΤΙΜΗ
Ø 16 x 1/2"	25008	3800154010521	10/270	3,62
Ø 16 x 3/4"	25009	2000000250090	10/240	
Ø 20 x 1/2"	25022	3800154010668	10/210	4,35
Ø 20 x 3/4"	25023	3800154010675	10/180	5,27

ΡΑΚΟΡ PRESS ΜΕ ΤΡΕΛΟ ΡΑΚΟΡ
PRESS FITTING FOR PEX AL PEX STRAIGHT WITH NUT



ΔΙΑΣΤΑΣΗ Dimension	ΚΩΔΙΚΟΣ Item №	Barcode		ΤΙΜΗ
Ø 16 x 1/2"	25013	3800154010583	10/240	3,35
Ø 20 x 3/4"	25028	3800154010750	10/180	4,82
Ø 16 x 3/4"	2501301	3800154056543	10/300	4,82
Ø 20 x 1/2"	2501300	3800154056604	10/300	4,82
Ø 26 x 1"	2502802	3800154056574	10/150	7,57
Ø 32 x 1"	2502803	3800154056628	5/100	11,37

ΤΑΦ ΣΥΝΔΕΣΗΣ PRESS
PRESS FITTING FOR PEX AL PEX TEE



ΔΙΑΣΤΑΣΗ Dimension	Αρτ. № Item №	Barcode		ΤΙΜΗ
Ø 16 x 16 x 16	25030	3800154010569	10/180	4,17
Ø 20 x 20 x 20	25027	3800154010736	10/20	5,79

ΤΑΦ ΑΡΣΕΝΙΚΟ PRESS
PRESS FITTING FOR PEX AL PEX TEE MALE



ΔΙΑΣΤΑΣΗ Dimension	ΚΩΔΙΚΟΣ Item №	Barcode		ΤΙΜΗ
Ø 16 x 1/2" x 16	25011	3800154010545	10/170	4,66
Ø 20 x 1/2" x 20	25025	3800154010699	10/150	5,50
Ø 20 x 3/4" x 20	25026	3800154010705	10/110	8,25

ΓΩΝΙΑ ΘΗΛΥΚΗ PRESS ΜΕ ΣΤΗΡΙΓΜΑ
PRESS FITTING FOR PEX AL PEX WALL ELBOW FEMALE



ΔΙΑΣΤΑΣΗ Dimension	ΚΩΔΙΚΟΣ Item №	Barcode		ΤΙΜΗ
Ø 16 x 1/2"	25014	3800154010576	10/160	5,48
Ø 20 x 1/2"	25029	3800154010743	10/140	6,24

ΓΩΝΙΑ ΣΥΝΔΕΣΗΣ PRESS
PRESS FITTING FOR PEX AL PEX ELBOW



ΔΙΑΣΤΑΣΗ Dimension	ΚΩΔΙΚΟΣ Item №	Barcode		ΤΙΜΗ
Ø 16 x 1/2"	25010	3800154010538	10/300	3,30
Ø 20 x 20	25024	3800154010682	10/200	4,98

ΤΑΦ ΘΗΛΥΚΟ PRESS
PRESS FITTING FOR PEX AL PEX TEE FEMALE



ΔΙΑΣΤΑΣΗ Dimension	ΚΩΔΙΚΟΣ Item №	Barcode		ΤΙΜΗ
Ø 16 x 1/2" x 16	25012	3800154010552	10/170	4,66
Ø 20 x 1/2" x 20	25037	3800154010712	10/120	5,63
Ø 20 x 3/4" x 20	25038	3800154010729	10/100	7,47

ΤΑΦ ΣΥΣΤΟΛΙΚΟ ΣΥΝΔΕΣΗΣ PRESS
PRESS FITTING FOR PEX AL PEX TEE REDUCING



ΔΙΑΣΤΑΣΗ Dimension	Αρτ. № Item №	Barcode		ΤΙΜΗ
Ø 20 x 16 x 20	25033	3800154026805	10/140	5,14
Ø 20 x 20 x 16	25034	3800154026812	10/140	5,19
Ø 20 x 16 x 16	25035	3800154026829	10/150	4,85
Ø 16 x 20 x 16	25036	3800154026836	10/150	5,06

ΘΕΡΜΑΝΣΗ HEATING

ΜΙΝΙ ΔΙΑΚΟΠΤΑΚΙ ΓΙΑ ΚΑΛΟΡΙΦΕΡ 1/2" Α BRASS MINI BALL VALVE 1/2" M

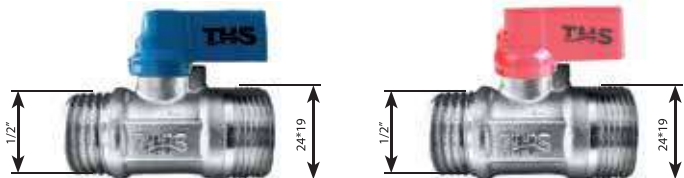

ΔΙΑΣΤΑΣΗ Dimension	ΚΩΔΙΚΟΣ Item N°	Barcode		ΤΙΜΗ
24*19 ΜΠΛΕ ΛΑΒΗ 24*19 BLUE HANDLE	6775	3800154028427	30/360	3,56
24*19 ΚΟΚΚΙΝΗ ΛΑΒΗ 24*19 RED HANDLE	6776	3800154028434	30/360	3,56

ΜΙΝΙ ΔΙΑΚΟΠΤΑΚΙ ΜΕ ΡΑΚΟΡ PEX-AL-PEX Α BRASS MINI BALL VALVE FOR PEX AL PEX PIPE MALE



ΔΙΑΣΤΑΣΗ Dimension	ΚΩΔΙΚΟΣ Item N°	Barcode		ΤΙΜΗ
Ø 16*1/2" ΜΠΛΕ ΛΑΒΗ BLUE HANDLE	2563	3800154009907	20/240	5,53
Ø 16*1/2" ΚΟΚΚΙΝΗ ΛΑΒΗ RED HANDLE	25631	3800154009914	20/240	6,26
Ø 20*1/2" ΜΠΛΕ ΛΑΒΗ BLUE HANDLE	2569	3800154009969	15/180	7,00
Ø 20*1/2" ΚΟΚΚΙΝΗ ΛΑΒΗ RED HANDLE	25691	3800154009976	15/180	7,00

ΜΙΝΙ ΔΙΑΚΟΠΤΑΚΙ ΜΕ ΡΑΚΟΡ PEX-AL-PEX Θ BRASS MINI BALL VALVE FOR PEX AL PEX PIPE FEMALE



ΔΙΑΣΤΑΣΗ Dimension	ΚΩΔΙΚΟΣ Item N°	Barcode		ΤΙΜΗ
Ø 16*1/2" ΜΠΛΕ ΛΑΒΗ BLUE HANDLE	2564	3800154009921	24/240	5,92
Ø 16*1/2" ΚΟΚΚΙΝΗ ΛΑΒΗ RED HANDLE	25641	3800154009938	24/240	4,56

ΜΙΝΙ ΔΙΑΚΟΠΤΑΚΙ ΜΕ ΡΑΚΟΡ PEX-AL-PEX/PEX-AL-PEX MINI BRASS BALL VALVE CHROME PLATED FF



ΔΙΑΣΤΑΣΗ Dimension	ΚΩΔΙΚΟΣ Item N°	Barcode		ΤΙΜΗ
Ø 16*Ø 16 ΜΠΛΕ ΛΑΒΗ BLUE HANDLE	2565	3800154009945	15/180	8,04
Ø 16*Ø 16 ΚΟΚΚΙΝΗ ΛΑΒΗ RED HANDLE	25651	3800154009952	15/180	8,04

TMS[®]
THERMOSTYLE



ΘΕΡΜΑΝΣΗ HEATING

ΠΙΝΑΚΑΣ ΥΔΡΟΛΗΨΙΑΣ ΕΝΤΟΙΧΙΖΟΜΕΝΟΣ INNER BOX FOR MANIFOLDS



ΔΙΑΣΤΑΣΗ Dimension	ΚΩΔΙΚΟΣ Item N°	Barcode		ΤΙΜΗ
450/400/100	2633	3800154012433	1/1	32,33
450/500/100	2634	3800154012440	1/1	37,68
450/600/100	2635	3800154012457	1/1	43,02
450/700/100	2639	3800154012464	1/1	49,73
450/800/100	2636	3800154012471	1/1	52,74
450/1200/100	7565	3800154029691	1/1	86,30

ΠΙΝΑΚΑΣ ΥΔΡΟΛΗΨΙΑΣ ΓΙΑ ΕΞΩΤΕΡΙΚΗ ΕΓΚΑΤΑΣΤΑΣΗ OUTER BOX FOR MANIFOLDS



ΔΙΑΣΤΑΣΗ Dimension	ΚΩΔΙΚΟΣ Item N°	Barcode		ΤΙΜΗ
450/400/110	2644	3800154012488	1/1	36,99
450/500/110	2643	3800154012495	1/1	42,47
450/600/110	2641	3800154012501	1/1	47,95
450/700/110	2640	3800154012518	1/1	54,05
450/800/110	2645	3800154012525	1/1	58,92
450/1200/110	7566	3800154029707	1/1	93,17

ΠΙΝΑΚΑΣ ΥΔΡΟΛΗΨΙΑΣ ΓΙΑ ΕΞΩΤΕΡΙΚΗ ΕΓΚΑΤΑΣΤΑΣΗ ΜΕ ΚΛΕΙΔΙ OUTER BOX FOR MANIFOLDS WITH LOCKER

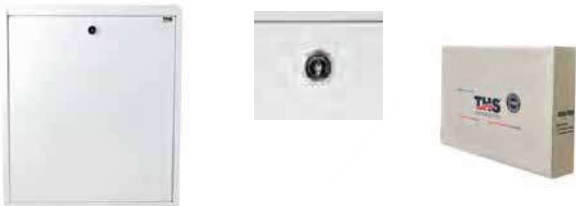

ΔΙΑΣΤΑΣΗ Dimension	ΚΩΔΙΚΟΣ Item N°	Barcode		ΤΙΜΗ
450/400/120	26441	3800154028250	1/1	40,79
450/500/120	26431	3800154028267	1/1	46,27
450/600/120	26411	3800154028274	1/1	51,77
450/700/120	26401	3800154028281	1/1	57,85
450/800/120	26451	3800154028298	1/1	62,72
450/1200/120	7615	3800154030420	1/1	

W - width
H - height
D - depth

W - ширина
H - височина
D - дълбочина



ΠΥΡΟΣΒΕΣΤΙΚΗ ΦΩΛΙΑ ΕΝΤΟΙΧΙΖΟΜΕΝΗ CABINET FOR FIRE VALVES



ΧΡΩΜΑ Color	ΚΩΔΙΚΟΣ Item N°	Barcode		ΤΙΜΗ
ΛΕΥΚΟ/WHITE	400006	3800154023477	1/1	89,32
ΚΟΚΚΙΝΟ/RED	4000061	3800154029141	1/1	93,04

ΠΥΡΟΣΒΕΣΤΙΚΗ ΦΩΛΙΑ ΕΞΩΤΕΡΙΚΗΣ ΕΓΚΑΤΑΣΤΑΣΗΣ CABINET FOR FIRE VALVES FOR OUTDOOR INSTALLATION



ΧΡΩΜΑ Color	ΚΩΔΙΚΟΣ Item N°	Barcode		ΤΙΜΗ
ΛΕΥΚΟ/WHITE	400007	3800154029127	1/1	83,74
ΚΟΚΚΙΝΟ/RED	400071	3800154029134	1/1	87,53

TMS
THERMOSTYLE



ΘΕΡΜΑΝΣΗ HEATING

ΑΝΤΛΙΑ ΚΥΚΛΟΦΟΡΙΑΣ ΕΝΕΡΓΕΙΑΚΗΣ ΑΠΟΔΟΣΗΣ Α
ENERGY SAVING CIRCULATING PUMPS

Шумоизоляция/
Sound insulation

Функция / Function
AUTO ADAPTIVE

Energy



ΔΙΑΣΤΑΣΗ Dimension	ΚΩΔΙΚΟΣ Item №	Barcode		ΤΙΜΗ
25/4 -22W	269101	3800154016462	1/8	156,60
25/6-45W	269111	3800154016479	1/8	168,54
32/6-45W	269121	3800154016486	1/8	170,96

ΑΝΤΛΙΑ ΚΥΚΛΟΦΟΡΙΑΣ ΕΝΕΡΓΕΙΑΚΗΣ ΑΠΟΔΟΣΗΣ Α
ENERGY SAVING CIRCULATING PUMP

Energy



ΔΙΑΣΤΑΣΗ Dimension	ΚΩΔΙΚΟΣ Item №	Barcode		ΤΙΜΗ
25/4	7756	3800154031465	1/8	137,34
25/6	7757	3800154017025	1/8	159,69
32/6	7758	3800154031472	1/8	161,92

ΚΥΚΛΟΦΟΡΗΤΗΣ ΑΝΑΚΥΚΛΟΦΟΡΙΑΣ
ENERGY SAVING CIRCULATING PUMP 130mm

Energy EEI ≤ 0.20



ΔΙΑΣΤΑΣΗ Dimension	ΚΩΔΙΚΟΣ Item №	Barcode		ΤΙΜΗ
25/ 6- 130 mm	100148	3800154054242	1/8	143,71



130 mm

ΑΝΤΛΙΑ ΚΥΚΛΟΦΟΡΙΑΣ
CIRCULATING PUMPS

ΡΑΚΟΡ ΚΥΚΛΟΦΟΡΗΤΗ
UNION WITH RUBBER FOR CIRCULATION PUMP



ΔΙΑΣΤΑΣΗ Dimension	ΚΩΔΙΚΟΣ Item №	Barcode		ΤΙΜΗ
25/40-38W-53W-72W-220V-50HZ	26910	3800154015540	1/8	
25/60-46W-67W-93W-220V-50HZ	26911	3800154015557	1/8	
32/60- 46W-67W-93W-220V-50HZ	26912	3800154015564	1/8	
32/80-150W-210W-270W-220V-50HZ	26913	3800154016981	1/8	

ΔΙΑΣΤΑΣΗ Dimension	ΚΩΔΙΚΟΣ Item №	Barcode		ΤΙΜΗ
25 - 1" * 1 1/2"	30302	3800154017018	1/140	1,83
32 - 1 1/4" * 2"	30303	3800154017025	1/80	3,25

Οι αντλίες №: 26910, 26911, 26912, 26913 είναι διαθέσιμες για πώληση μόνο ΕΚΤΟΣ ΕΕ
The pumps with codes 26910, 26911, 26912, 26913 are available for sales only out of EU

TMS[®]
THERMOSTYLE



ΘΕΡΜΑΝΣΗ HEATING

ΜΑΝΟΜΕΤΡΟ ΠΛΑΤΗΣ MANOMETER AXIAL

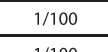
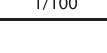

ΔΙΑΣΤΑΣΗ Dimension	ΚΩΔΙΚΟΣ Item №	Barcode		ΤΙΜΗ
0 - 6 bar. Ø 60	2448	3800154009556		4,61
0 - 10 bar. Ø 60	2439	3800154009563		4,61

ΜΑΝΟΜΕΤΡΟ ΟΡΘΙΟ MANOMETER RADIAL

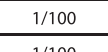
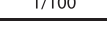

ΔΙΑΣΤΑΣΗ Dimension	ΚΩΔΙΚΟΣ Item №	Barcode		ΤΙΜΗ
0 - 6 bar. Ø 60	2427	3800154009570		4,61
0 - 10 bar. Ø 60	2426	3800154009587		4,61

ΜΑΝΟΜΕΤΡΟ ΘΕΡΜΟΚΡΑΣΙΑΣ-ΠΙΕΣΗΣ ΠΛΑΤΗΣ TERMOMANOMETER AXIAL Ø 80 1/2"



ΔΙΑΣΤΑΣΗ Dimension	ΚΩΔΙΚΟΣ Item №	Barcode		ΤΙΜΗ
0-10 bar. 20°-120°	2475	3800154009679		12,73

ΜΑΝΟΜΕΤΡΟ ΘΕΡΜΟΚΡΑΣΙΑΣ-ΠΙΕΣΗΣ ΟΡΘΙΟ TERMOMANOMETER AXIAL Ø 80 1/2"

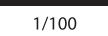

ΔΙΑΣΤΑΣΗ Dimension	ΚΩΔΙΚΟΣ Item №	Barcode		ΤΙΜΗ
0-10 bar. 20°-120°	2469	3800154009686		11,76



ΘΕΡΜΟΜΕΤΡΟ TERMOMETER



ΔΙΑΣΤΑΣΗ Dimension	ΚΩΔΙΚΟΣ Item №	Barcode		ΤΙΜΗ
0° - 120° Ø 38	2474	3800154009648		6,71



ΘΕΡΜΟΜΕΤΡΟ TERMOMETER 0°-120°



ΔΙΑΣΤΑΣΗ Dimension	ΚΩΔΙΚΟΣ Item №	Barcode		ΤΙΜΗ
Ø 40 1/2"	7754	3800154031458		8,54
Ø 40 1/4"	7753	3800154031441		8,28

ΒΑΛΒΙΔΑ ΑΣΦΑΛΕΙΑΣ BRASS SAFE VALVE

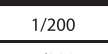
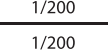
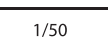

ΔΙΑΣΤΑΣΗ Dimension	ΚΩΔΙΚΟΣ Item №	Barcode		ΤΙΜΗ
1/2" 2.5 bar	24170	3800154009525		5,97
1/2" 3 bar	24171	3800154009532		5,97
1/2" 6 bar	24172	3800154009549		5,97
3/4" movable nut 7bar	100309	3800154053788		11,40

ΑΝΤΑΠΤΟΡΑΣ 1/2x1/4 BRASS FITTING

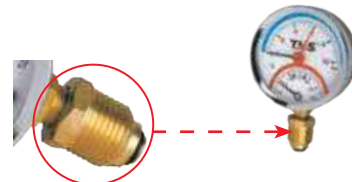

ΔΙΑΣΤΑΣΗ Dimension	ΚΩΔΙΚΟΣ Item №	Barcode		ΤΙΜΗ
1/2"Μ x 1/4"Ж 1/2"Μ x 1/4"F	8481	3800154032554		5,11

TMS
THERMOSTYLE



ΘΕΡΜΑΝΣΗ HEATING



ΔΟΧΕΙΟ ΔΙΑΣΤΟΛΗΣ ΟΡΙΖΟΝΤΙΟ ΑΡΙΣΤΕΡΟ EXTENSION TANK HORIZONTAL LEFT



ΔΙΑΣΤΑΣΗ Dimension	ΚΩΔΙΚΟΣ Item №	Barcode	 	ΤΙΜΗ
8 ΛΙΤΡΑ/LITERS	32010	3800154012259	1/1	
12 ΛΙΤΡΑ/LITERS	32011	3800154012266	1/1	
18 ΛΙΤΡΑ/LITERS	32012	3800154012273	1/1	
30 ΛΙΤΡΑ/LITERS	32013	3800154012280	1/1	
50 ΛΙΤΡΑ/LITERS	32014	3800154012297	1/1	

ΔΟΧΕΙΟ ΔΙΑΣΤΟΛΗΣ ΟΡΙΖΟΝΤΙΟ ΔΕΞΙ EXTENSION TANK HORIZONTAL RIGHT



ΔΙΑΣΤΑΣΗ Dimension	ΚΩΔΙΚΟΣ Item №	Barcode	 	ΤΙΜΗ
8 ΛΙΤΡΑ/LITERS	320101	3800154024047	1/1	
12 ΛΙΤΡΑ/LITERS	320111	3800154026997	1/1	
18 ΛΙΤΡΑ/LITERS	320121	3800154027000	1/1	
30 ΛΙΤΡΑ/LITERS	320131	3800154027017	1/1	
50 ΛΙΤΡΑ/LITERS	320141	3800154027024	1/1	



ΔΟΧΕΙΟ ΔΙΑΣΤΟΛΗΣ ΚΑΘΕΤΟ ΑΡΙΣΤΕΡΟ EXTENSION TANK VERTICAL LEFT



ΔΙΑΣΤΑΣΗ Dimension	ΚΩΔΙΚΟΣ Item №	Barcode	 	ΤΙΜΗ
8 ΛΙΤΡΑ/LITERS	32000	3800154012303	1/1	
12 ΛΙΤΡΑ/LITERS	32001	3800154012310	1/1	
18 ΛΙΤΡΑ/LITERS	32002	3800154012327	1/1	
30 ΛΙΤΡΑ/LITERS	32003	3800154012334	1/1	
50 ΛΙΤΡΑ/LITERS	32004	3800154012341	1/1	



ΔΟΧΕΙΟ ΔΙΑΣΤΟΛΗΣ ΚΑΘΕΤΟ ΔΕΞΙ EXTENSION TANK VERTICAL RIGHT



ΔΙΑΣΤΑΣΗ Dimension	ΚΩΔΙΚΟΣ Item №	Barcode	 	ΤΙΜΗ
8 ΛΙΤΡΑ/LITERS	320001	3800154027031	1/1	
12 ΛΙΤΡΑ/LITERS	320011	3800154023668	1/1	
18 ΛΙΤΡΑ/LITERS	320021	3800154023675	1/1	
30 ΛΙΤΡΑ/LITERS	320031	3800154027055	1/1	
50 ΛΙΤΡΑ/LITERS	320041	3800154027062	1/1	

ΔΟΧΕΙΟ ΔΙΑΣΤΟΛΗΣ UNIVERSAL EXTENSION TANK ALL-PURPOSE



ΔΙΑΣΤΑΣΗ Dimension	ΚΩΔΙΚΟΣ Item №	Barcode	 	ΤΙΜΗ
8 ΛΙΤΡΑ/LITERS	5640	3800154027079	1/1	42,78
13 ΛΙΤΡΑ/LITERS	5641	3800154027086	1/1	51,17
17 ΛΙΤΡΑ/LITERS	5642	3800154027093	1/1	57,67
23 ΛΙΤΡΑ/LITERS	5643	3800154027109	1/1	64,19
33 ΛΙΤΡΑ/LITERS	5644	3800154027116	1/1	71,63

THS[®]
THERMOSTYLE



ΔΟΧΕΙΟ ΔΙΑΣΤΟΛΗΣ ΟΡΙΖΟΝΤΙΟ
EXTENSION TANK HORIZONTAL



ΔΙΑΣΤΑΣΗ Dimension	ΚΩΔΙΚΟΣ Item №	Barcode		ΤΙΜΗ
8 ΛΙΤΡΑ/LITERS	10283	3800154041259	1/1	40,64
12 ΛΙΤΡΑ/LITERS	10284	3800154041266	1/1	45,85
18 ΛΙΤΡΑ/LITERS	10285	3800154041273	1/1	54,78

ΔΟΧΕΙΟ ΔΙΑΣΤΟΛΗΣ ΚΑΘΕΤΟ
EXTENSION TANK VERTICAL



ΔΙΑΣΤΑΣΗ Dimension	ΚΩΔΙΚΟΣ Item №	Barcode		ΤΙΜΗ
8 ΛΙΤΡΑ/LITERS	10286	3800154041280	1/1	40,64
12 ΛΙΤΡΑ/LITERS	10287	3800154041297	1/1	45,85
18 ΛΙΤΡΑ/LITERS	10288	3800154041303	1/1	54,78



ΔΟΧΕΙΟ ΔΙΑΣΤΟΛΗΣ
PRESSURE CONTROL TANKS



ΔΙΑΣΤΑΣΗ Dimension	ΚΩΔΙΚΟΣ Item №	Barcode	 	ΤΙΜΗ
5 ΛΙΤΡΑ/LITERS	5001	3800154012358	1/1	28,85
8 ΛΙΤΡΑ/LITERS	5002	3800154012365	1/1	32,65
12 ΛΙΤΡΑ/LITERS	5003	3800154012372	1/1	35,74
19 ΛΙΤΡΑ/LITERS	5004	3800154012389	1/1	41,16
24 ΛΙΤΡΑ/LITERS	5005	3800154012396	1/1	47,34
36 ΛΙΤΡΑ/LITERS	5006	3800154012402	1/1	64,37

ΔΟΧΕΙΟ ΔΙΑΣΤΟΛΗΣ ΜΕ ΠΟΔΙΑ
PRESSURE CONTROL TANKS WITH LEGS



ΔΙΑΣΤΑΣΗ Dimension	ΚΩΔΙΚΟΣ Item №	Barcode	 	ΤΙΜΗ
50 ΛΙΤΡΑ/LITERS	5007	3800154012419	1/1	95,37

ΔΟΧΕΙΟ ΔΙΑΣΤΟΛΗΣ ΜΕ ΠΟΔΙΑ
ΚΑΙ ΜΑΝΟΜΕΤΡΟ
PRESSURE CONTROL TANKS WITH LEGS AND INBUILT MANOMETER



ΔΙΑΣΤΑΣΗ Dimension	ΚΩΔΙΚΟΣ Item №	Barcode	 	ΤΙΜΗ
80 ΛΙΤΡΑ/LITERS	5008	3800154012426	1/1	148,13
100 ΛΙΤΡΑ/LITERS	5009	3800154027123	1/1	176,27
150 ΛΙΤΡΑ/LITERS	5010	3800154027130	1/1	266,77

ΜΑΓΝΗΤΙΚΟ ΦΙΛΤΡΟ

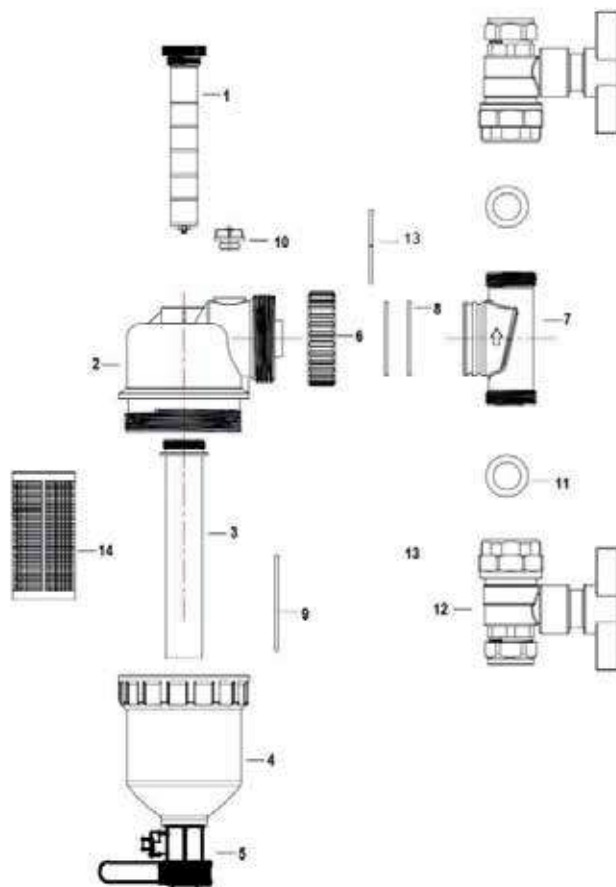

ΔΙΑΣΤΑΣΗ Dimension	ΚΩΔΙΚΟΣ Item N°	Barcode		ΤΙΜΗ
3/4"	1000431	3800154056864	1/6	116,12
1"	100043	3800154053283	1/6	116,12

Description :	N°	Περιγραφή
Magnetic bar-12 000 gaus	1	Μαγνήτης 12000 gaus
Filter body - plastic	2	Σώμα πλαστικό
Cleaning cover	3	Κάλυμμα καθαρισμού
Filter body - plastic	4	Σώμα πλαστικό
Drain-off valve	5	Βάνα καθαρισμού
Color cap	6	Κάλυμμα
Rotating joint	7	Περιστροφικός σύνδεσμος
O ring	8	O-ring
O ring	9	O-ring
Air-vent	10	Εξαεριστικό
Shim	11	Δαχτυλίδι
Brass ball valves 1"	12	Βάνα 1"
Snap ring	13	Δαχτυλίδι
Plastic filter	14	Πλαστικό φίλτρο

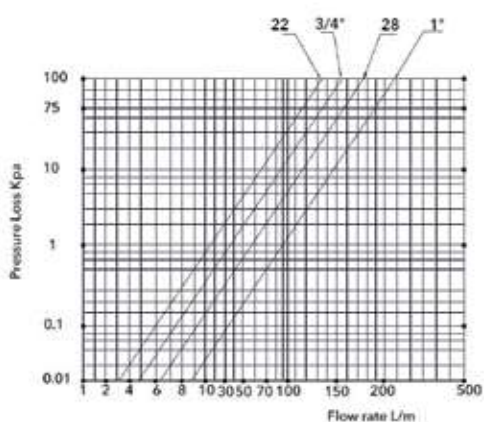

Size	KVS(m ³ /h)
22	8.1
3/4"	9.3
28	10.5
1"	14.5



ΣΕΤ ΣΤΗΡΙΞΗΣ ΔΟΧΕΙΟΥ ΔΙΑΣΤΟΛΗΣ ΑΝΟΞΕΙΔΩΤΟ SAFETY GROUP STAINLESS STEEL

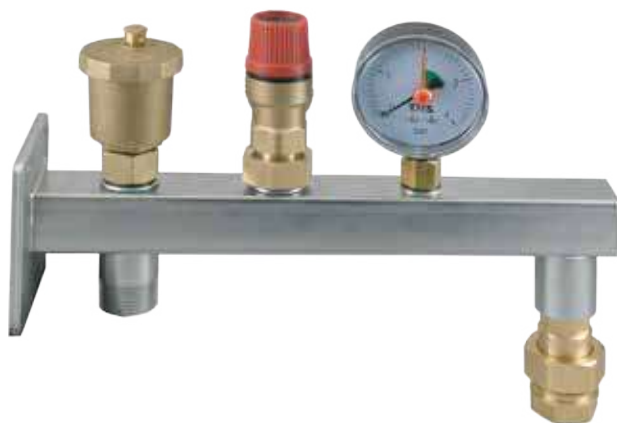

99992
3 bar.

Το σετ περιλαμβάνει:

- Μεταλλικό σώμα- ανοξείδωτο ατσάλι
- Βόλτα 3/4" αρσενική
- Αυτόματο εξαεριστικό με βαλβίδα αντεπίστροφής 1/2"
- Βαλβίδα ασφαλείας με ρακόρ Θ 3/4" - 3bar
- Μανόμετρο Ø63, 1/4" 0-4 bar και κλίμακα ένδειξης
- Αυτόματο εξαεριστικό με βαλβίδα αντεπίστροφής 1/2"
- Διπλή αντεπίστροφη 3/4" ΑΘ

The set includes:

- Metal posture - stainless steel
- Hole 3/4" male tread on the posture
- Automatic air vent 1/2" with check valve 1/2" for purger
- Safety valve with removable nut 3/4" F - 3 bar.
- Manometer ver cal rough Ø 63, 1/4", 0 - 4 bar. and scale with green sector from 2 bar. to 3 bar.
- Double check valve 3/4" MF

Το σετ περιλαμβάνει:

- Μεταλλικό σώμα- ανοξείδωτο ατσάλι
- Βόλτα 3/4" αρσενική
- Αυτόματο εξαεριστικό με βαλβίδα αντεπίστροφής 1/2"
- Βαλβίδα ασφαλείας με ρακόρ Θ 3/4" - 7bar
- Μανόμετρο Ø63, 1/4" 0-10 bar και κλίμακα ένδειξης
- Αυτόματο εξαεριστικό με βαλβίδα αντεπίστροφής 1/2"
- Διπλή αντεπίστροφη 3/4" ΑΘ

The set includes:

- Metal posture - stainless steel
- Hole 3/4" male tread on the posture
- Automatic air vent 1/2" with check valve 1/2" for purger
- Safety valve with removable nut 3/4" F - 7 bar.
- Manometer ver cal rough Ø 63, 1/4", 0 - 10 bar. and scale with green sector from 5 bar. to 7 bar.
- Double check valve 3/4" MF

ΔΙΑΣΤΑΣΗ Dimension	ΚΩΔΙΚΟΣ Item N°	Barcode		ΤΙΜΗ
3 bar.	99992	3800154053313	1/10	47,47
7 bar.	100118	3800154053429	1/10	51,56

ΣΕΤ ΣΤΗΡΙΞΗΣ ΔΟΧΕΙΟΥ ΔΙΑΣΤΟΛΗΣ SAFETY GROUP



100117
3 bar.

Το σετ περιλαμβάνει:

- Μεταλλικό σώμα- κόκκινο χρώμα
- Βόλτα 3/4" θηλυκή
- Αυτόματο εξαεριστικό με βαλβίδα αντεπίστροφής 1/2"
- Βαλβίδα ασφαλείας αρσενική 1/2" - 7bar
- Μανόμετρο Ø63, 1/4" 0-4 bar και κλίμακα ένδειξης
- Αυτόματο εξαεριστικό με βαλβίδα αντεπίστροφής 1/2"
- Διπλή αντεπίστροφη 3/4" ΑΘ

The set includes:

- Metal posture - red color
- Hole 3/4" female tread on the posture
- Automatic air vent 1/2" with check valve 1/2" for purger
- Safety valve 1/2" M x 3/4" F - 3 bar.
- Manometer ver cal rough Ø 63, 1/4", 0 - 4 bar. and scale with green sector from 2 bar. to 3 bar.
- Double check valve 3/4" MF

Το σετ περιλαμβάνει:

- Μεταλλικό σώμα- ανοξείδωτο ατσάλι
- Βόλτα 3/4" θηλυκή
- Αυτόματο εξαεριστικό με βαλβίδα αντεπίστροφής 1/2"
- Βαλβίδα ασφαλείας αρσενική 1/2" - 7bar
- Μανόμετρο Ø63, 1/4" 0-10 bar και κλίμακα ένδειξης
- Αυτόματο εξαεριστικό με βαλβίδα αντεπίστροφής 1/2"
- Διπλή αντεπίστροφη 3/4" ΑΘ

The set includes:

- Metal posture - red color
- Hole 3/4" female tread on the posture
- Automatic air vent 1/2" with check valve 1/2" for purger
- Safety valve 1/2" M x 3/4" F - 7 bar.
- Manometer ver cal rough Ø 63, 1/4", 0-10 bar. and scale with green sector from 5 bar. to 7 bar.
- Double check valve 3/4" MF

ΔΙΑΣΤΑΣΗ Dimension	ΚΩΔΙΚΟΣ Item N°	Barcode		ΤΙΜΗ
3 bar.	100117	3800154053450	1/10	45,04
7 bar.	99993	3800154053344	1/10	44,67

TMS[®]
THERMOSTYLE





office@thermostyle.bg

www.thermostyle.bg

